

CONCEALED ADJUSTABLE HINGES





CONCEALED HINGES

CEAM® Hinges are available at PMI for use in a variety of application, including table tops, doorways, closets, storage areas and now cabinets!!

The **CEAM**® hinges come in a variety of finishes to complement any door. The perfect symmetry between the 2 sides of the hinge allows for a complete reversibility. 5 different models are available for you to choose from and are compatible with wooden, aluminum, and steel doors.

CEAM® offers a minimum jamb width from 15mm to 29mm (Best in Class).

Tested for 200,000 opening cycles.

Fire rating available upon request.

CEAM® CONCEALED & ADJUSTABLE HINGES



The **CEAM**® hinges have a 3 axes adjustability that makes it easy to do a final detailed calibration to the door position. Look for the  to find more information about the hinge's 3D adjustability tolerance.

Elegant and minimalist design with no visible screws (except SS)

ROUTING TEMPLATES

Routing templates, inserts and accessories are offered to provide an fast and reliable installation.









Please call our customer service for more information: 800-222-6941

Remember that all of our **CEAM**® Concealed Hinges are 100%

made in italy



TABLE OF CONTENTS



4	1130SS 134 x 24 mm 2 Hinge Capacity = 95 lbs.	
6	1131 160 x 32 mm 2 Hinge Capacity = 176 lbs.	
8	1230 130 x 30 mm 2 Hinge Capacity = 110 lbs.	
10	1430 128 x 22 mm 2 Hinge Capacity = 88 lbs.	
12	1431 180 x 32 mm 2 Hinge Capacity = 254 lbs.	
14	1432 230 x 32 mm 2 Hinge Capacity = 397 lbs.	
16	1432W 230 x 32 mm 2 Hinge Capacity = 353 lbs.	
18	929 76 x 14 mm 2 Hinge Capacity = 26 lbs.	
20	2010SS 89 x 25 mm 2 Hinge Capacity = 88 lbs.	

FINISHES AVAILABLE



22 Routing Templates & Accessories



MODEL	TECHNOLOGY	MATERIAL	DIMENSION L - W - D mm / Inches	MINIMUM DOOR THICKNESS mm / Inches	RANGE OF REVERSIBILITY mm / Inches	LOAD CAPACITY kg / lbs		FIREPROOF min.
						2 hinge	3 hinge	
1130SS	Concealed Hinge	Stainless Steel	134.5 x 24 x 21 mm 5 5/16" x 1 5/16" x 13/16"	30 mm 1 3/16"	30 - 33 mm 1 3/16" - 1 5/16"	43 kg 95 lbs	65 kg 143 lbs	
1131	Concealed Hinge	Zinc	160 x 32 x 29 mm 6 5/16" x 1 1/4" x 1 1/8"	38 mm 1 1/2"	38 - 46 mm 1 1/2" - 1 13/16"	80 kg 176 lbs	120 kg 265 lbs	
1230	Concealed Hinge	Zinc	130 x 30 x 21 mm 5 1/8" x 1 3/16" x 13/16"	35 mm 1 3/8"	35 - 45 mm 1 3/8" - 1 3/4"	50 kg 110 lbs	70 kg 154 lbs	
1430	Concealed Hinge	Zinc	128 x 22 x 21 mm 5 1/16" x 7/8" x 13/16"	28 mm 1 1/8"	28 - 34 mm 1 1/8" - 1 5/16"	40 kg 88 lbs	60 kg 132 lbs	
1431	Concealed Hinge	Zinc	180 x 32 x 29 mm 7 1/16" x 1 1/4" x 1 1/8"	38 mm 1 1/2"	38 - 45 mm 1 1/2" - 1 3/4"	115 kg 254 lbs	140 kg 309 lbs	
1432	Concealed Hinge	Zinc and Aluminum	230 x 32 x 32 mm 9 1/16" x 1 1/4" x 1 1/4"	38 mm 1 1/2"	38 - 45 mm 1 1/2" - 1 3/4"	180 kg 397 lbs	205 kg 452 lbs	
1432W	Concealed Hinge	Zinc and Aluminum	230 x 32 x 32 mm 9 1/16" x 1 1/4" x 1 1/4"	38 mm 1 1/2"	N/A	160 kg 353 lbs	185 kg 408 lbs	
929	Concealed Hinge	Zinc and Fiberglass	76 x 14 x 15 mm 3" x 9/16" x 5/8"	18 mm 11/16"	18 - 21 mm 11/16" - 13/16"	12 kg 26 lbs	16 kg 35 lbs	
2010SS	Concealed Hinge	Stainless Steel & Nylon	89 x 25 x 27.3 mm 3 1/2" x 1" x 1 1/16"	31 mm 1 1/4"	31 - 33 mm 1 1/4" - 1 5/16"	40 kg 88 lbs	60 kg 132 lbs	

Note: Manufacturing tolerance are based on metric dimensions.
Fractions are for reference only.

3D Invisible Hinge

1130SS

134 x 24 mm

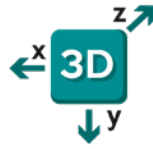
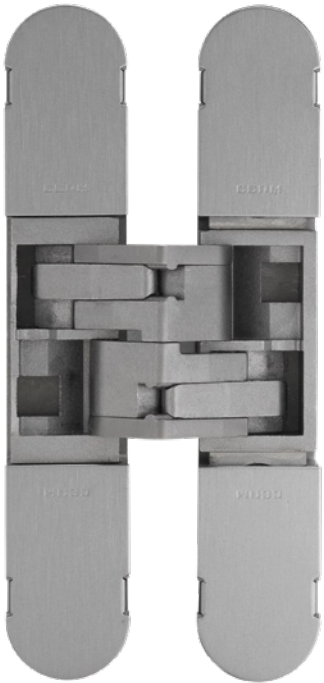

- Manufactured in #304 Stainless Steel
- Suitable for doors of 30 mm min. thickness
- Total Length of 134 mm
- Only 21 mm of depth
- 3D adjustments
- Load capacity up to 143 lbs / 65 kg with 3 hinges
- Screws and instructions included



Item Number	Description	Packed
C1130SS	3D Invisible Hinge 134 x 24 mm Stainless Steel	3 / Box
C1130FIX	1130 Series Routing Fixture	1 / Box
C1130TEMP	1130 Series Inserts for Routing Fixtures	1 Set / Box

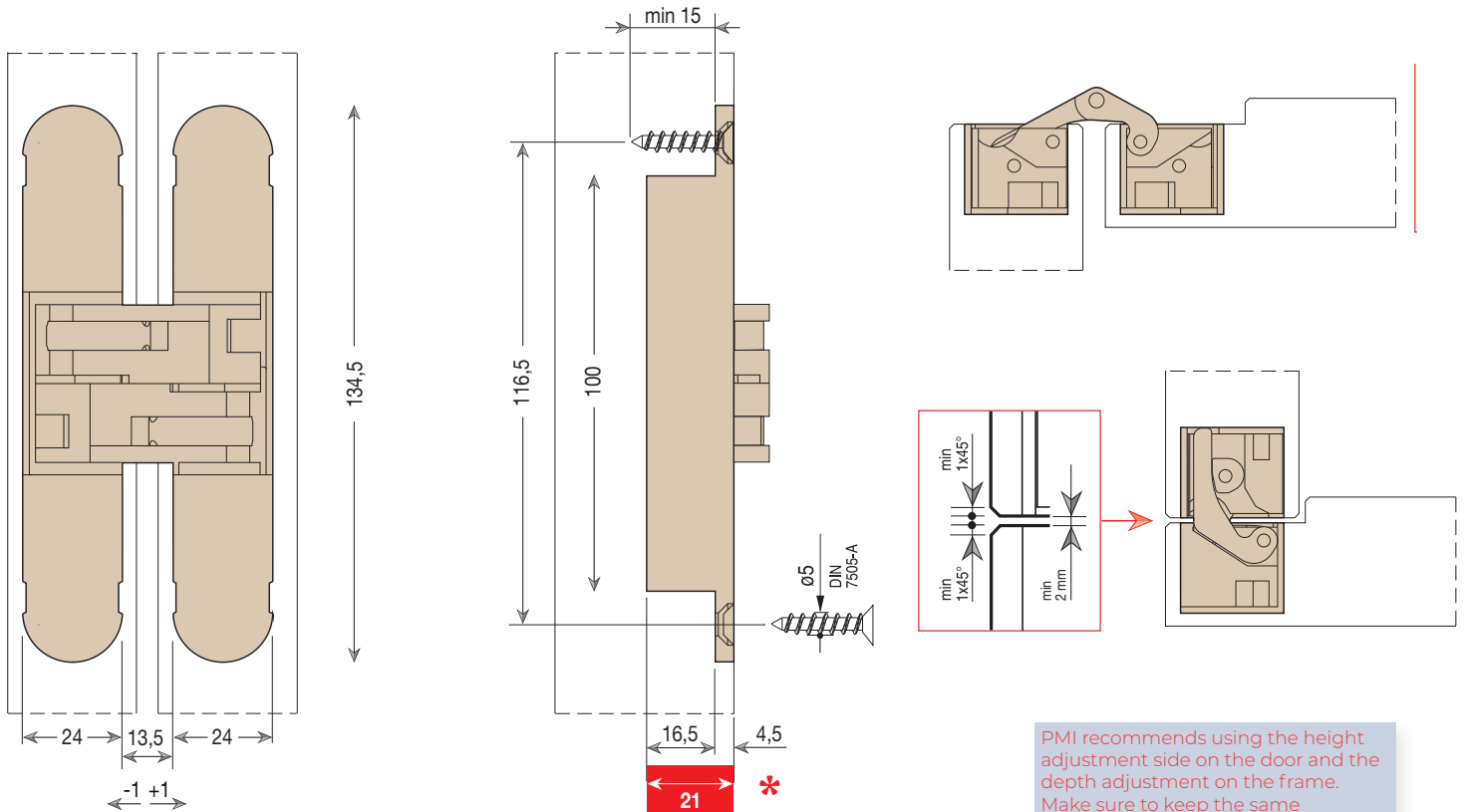

* Small Routing Depth

PMI recommends using the height adjustment side on the door and the depth adjustment on the frame. Make sure to keep the same adjustment type on the same side.

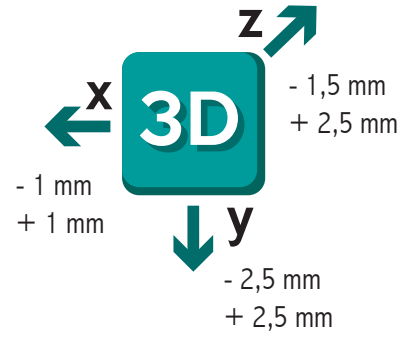
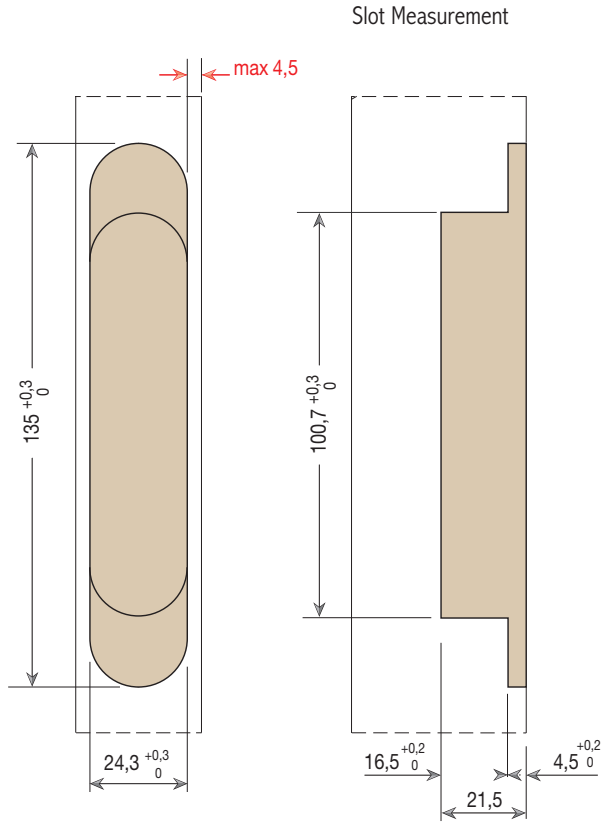

REVERSIBILITY

Reversible for doors from 30 mm to 33 mm thick

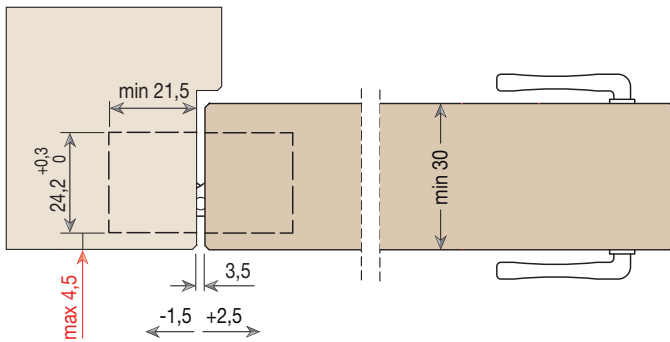
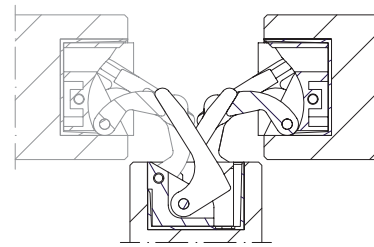

Door cross-section

1130SS HINGE LOAD CAPACITY CHART

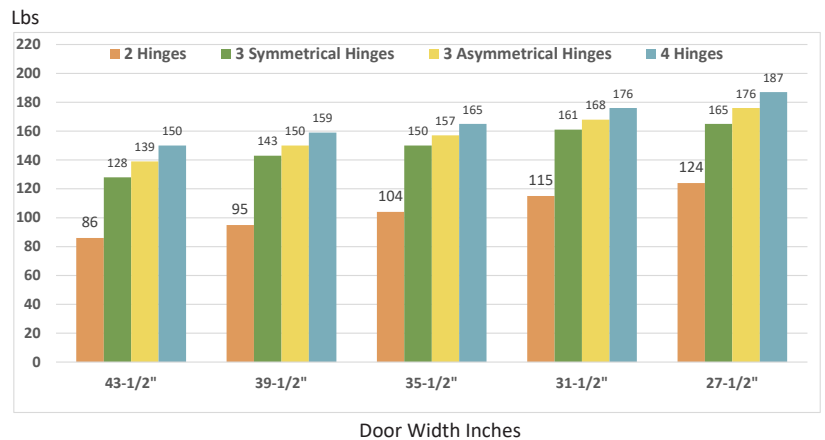
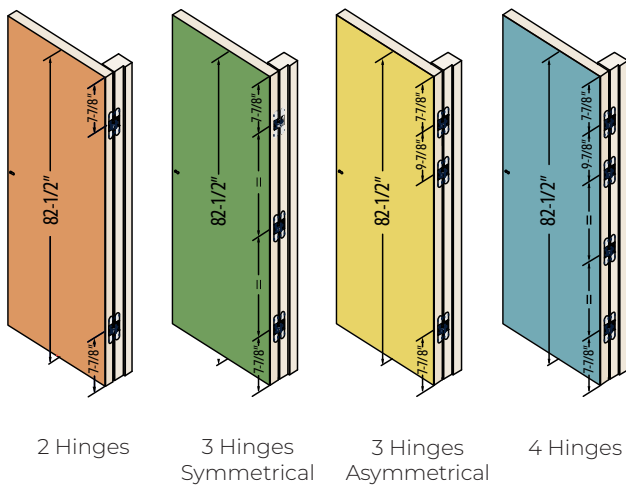

3D Invisible Hinge

1131
160 x 32 mm

MAINTENANCE**FREE**

- Manufactured in Zinc
- Fire proof and UL Certified
- Suitable for doors of 38 mm min. thickness
- Total Length of 160 mm
- Only 29 mm of depth
- 3D adjustments
- Load capacity up to 265 lbs / 120 kg with 3 hinges
- Screws and instructions included

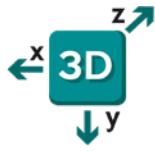

Item Number	Description	Packed
C1131SIL	3D Invisible Hinge 160 x 32 mm Silver Painted	3 / Box
C1131NK	3D Invisible Hinge 160 x 32 mm Nickel Plated	3 / Box
C1131SNI	3D Invisible Hinge 160 x 32 mm Satin Nickel Plated	3 / Box
C1131BBR	3D Invisible Hinge 160 x 32 mm Brushed Bronze	3 / Box
C1131BLK	3D Invisible Hinge 160 x 32 mm Matte Black Painted	3 / Box
C1131/1230FIX	1131 / 1230 Series Routing Fixture	1 / Box
C1131TEMP	1131 Series Inserts for Routing Fixtures	1 Set / Box
C1131FFP	1131 Series Frame Fixing Plate	1 / Box
C1131WFP	1131 Series Wall Fixing Plate	1 / Box

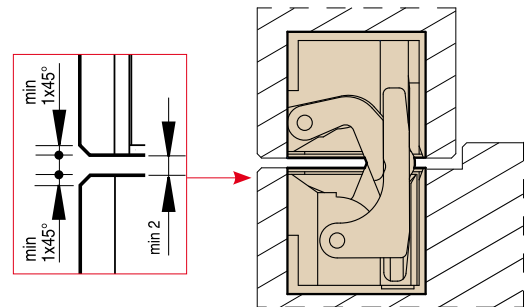
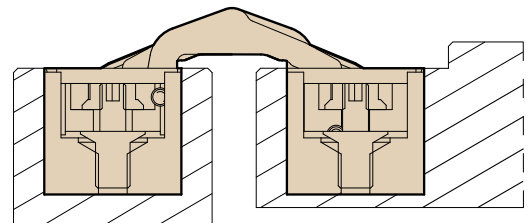
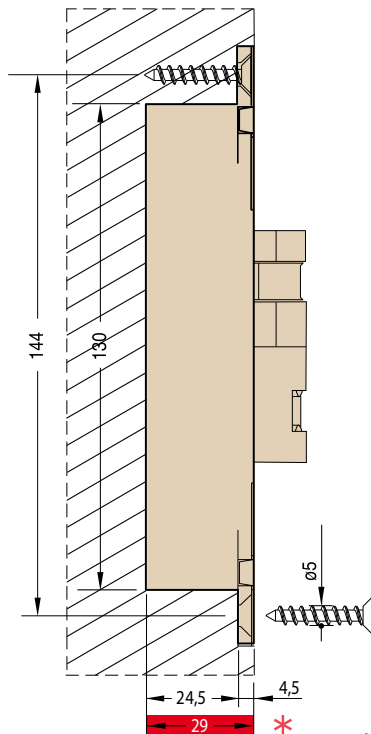
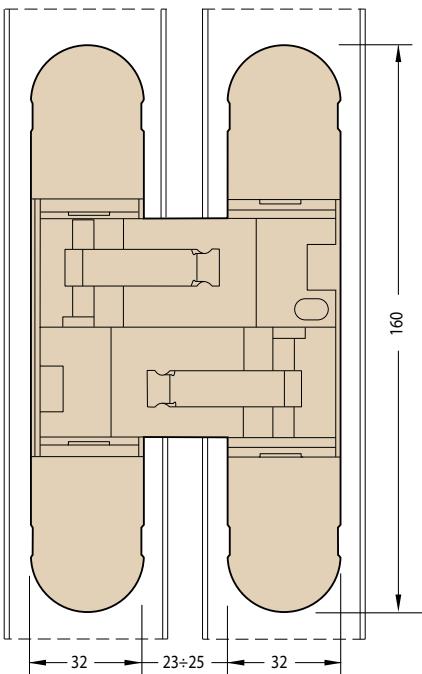

PMI recommends using the height adjustment side on the door and the depth adjustment on the frame. Make sure to keep the same adjustment type on the same side.

*Small Routing Depth

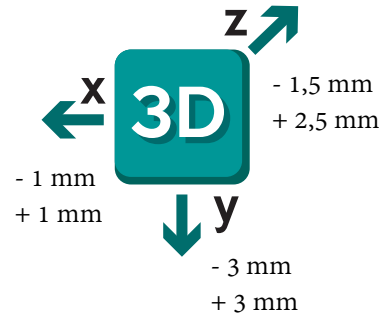
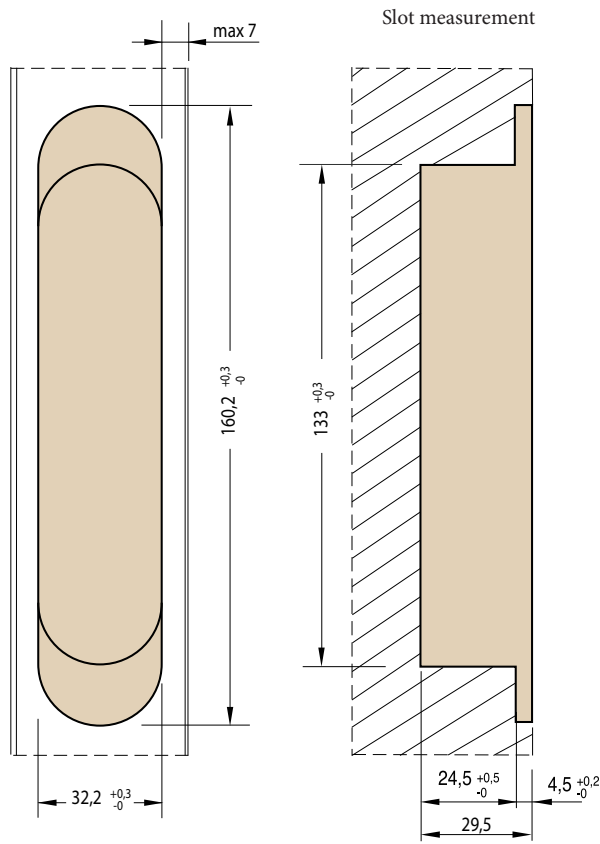

REVERSIBILITY

Reversible for doors from 38 mm to 46 mm thick

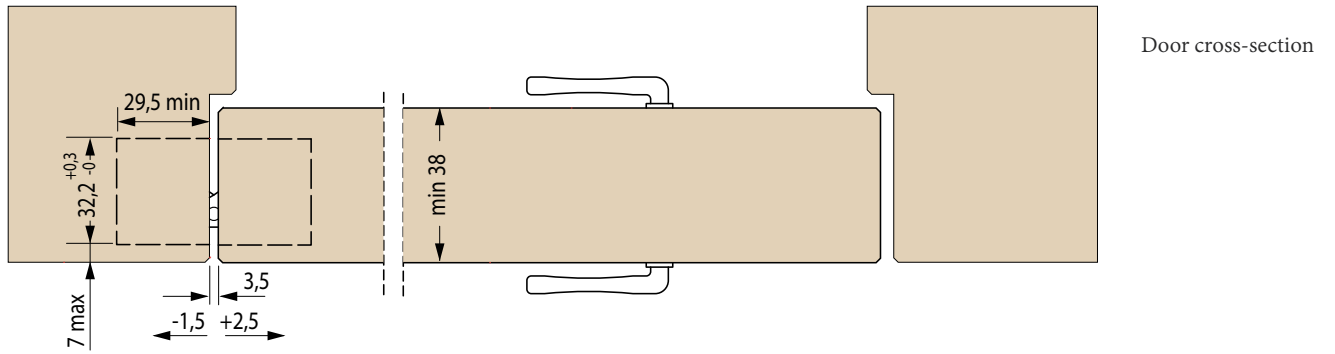
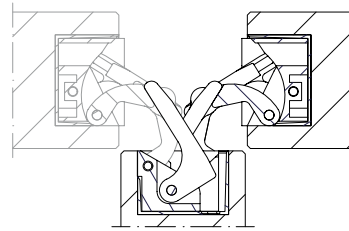

1131 HINGE LOAD CAPACITY CHART

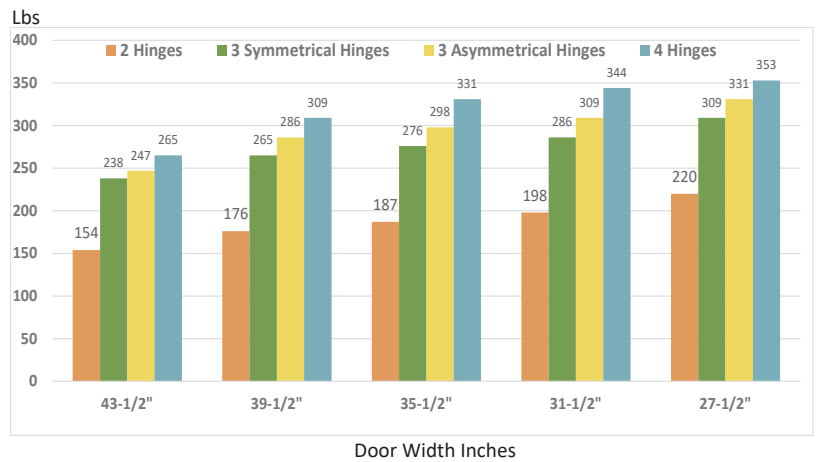
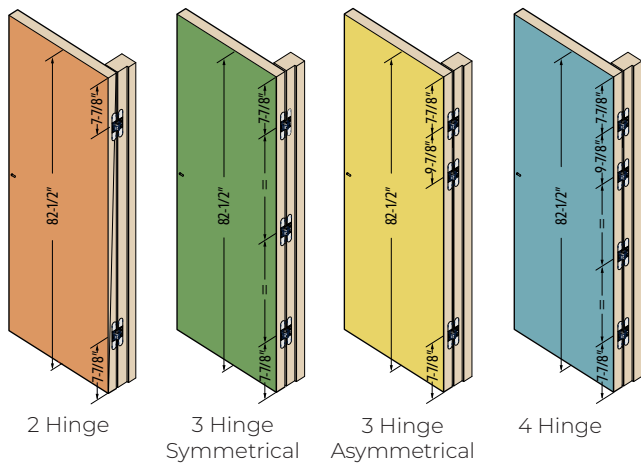

1230
130 x 30 mm

MAINTENANCEFREE

- Manufactured in Zinc
- Suitable for doors of 35 mm min. thickness
- Total length of 130 mm
- Only 21 mm of depth
- 3D adjustments
- Load capacity up to 154 lbs / 70 kg with 3 hinges
- Screws and instructions included



Item Number	Description	Packed
C1230SIL	3D Invisible Hinge 130 x 30 mm Silver Painted	3 / Box
C1230NK	3D Invisible Hinge 130 x 30 mm Nickel Plated	3 / Box
C1230SNI	3D Invisible Hinge 130 x 30 mm Satin Nickel Plated	3 / Box
C1230BBR	3D Invisible Hinge 130 x 30 mm Brushed Bronze	3 / Box
C1230BLK	3D Invisible Hinge 130 x 30 mm Matte Black Painted	3 / Box
C1131/1230FIX	1131 / 1230 / Series Routing Fixture	1 / Box
C1230TEMP	1230 Series Inserts for Routing Fixtures	1 Set / Box
C1230FFP	1230 Series Frame Fixing Plate	1 / Box
C1230WFP	1230 Series Wall Fixing Plate	1 / Box

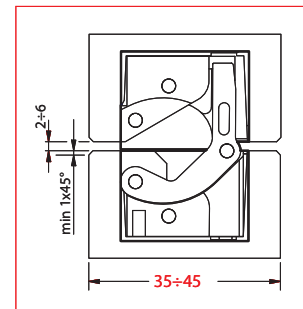
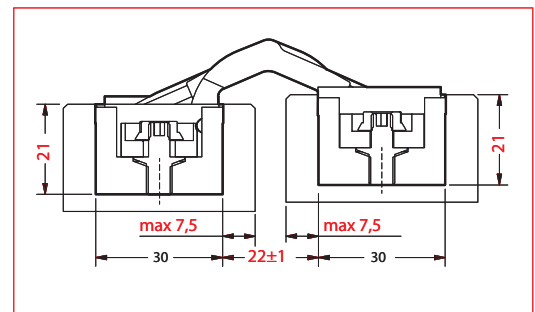
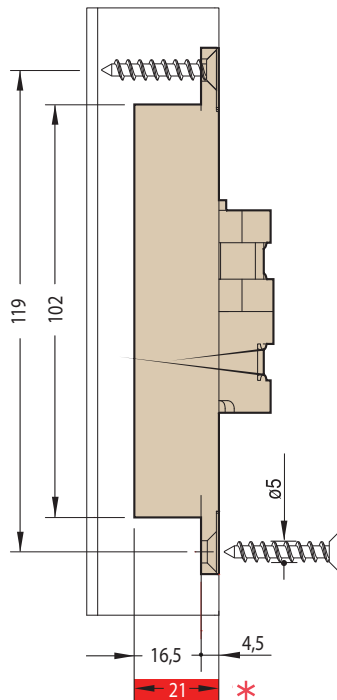
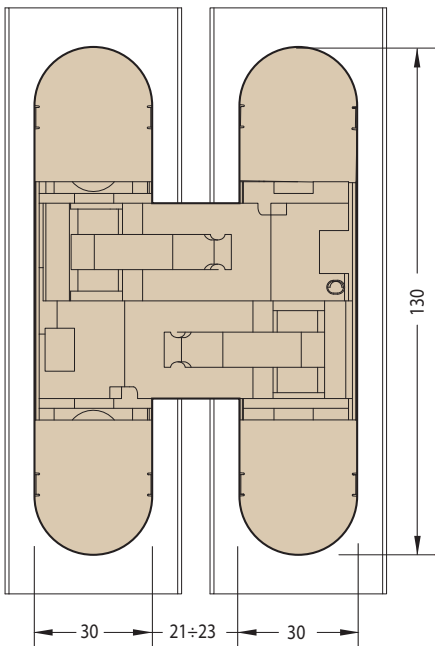

PMI recommends using the height adjustment side on the door and the depth adjustment on the frame. Make sure to keep the same adjustment type on the same side.

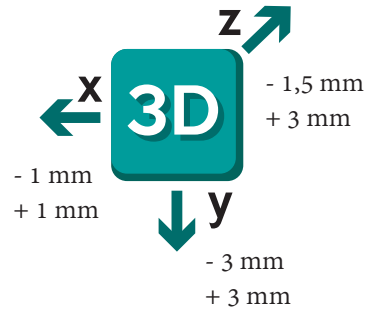
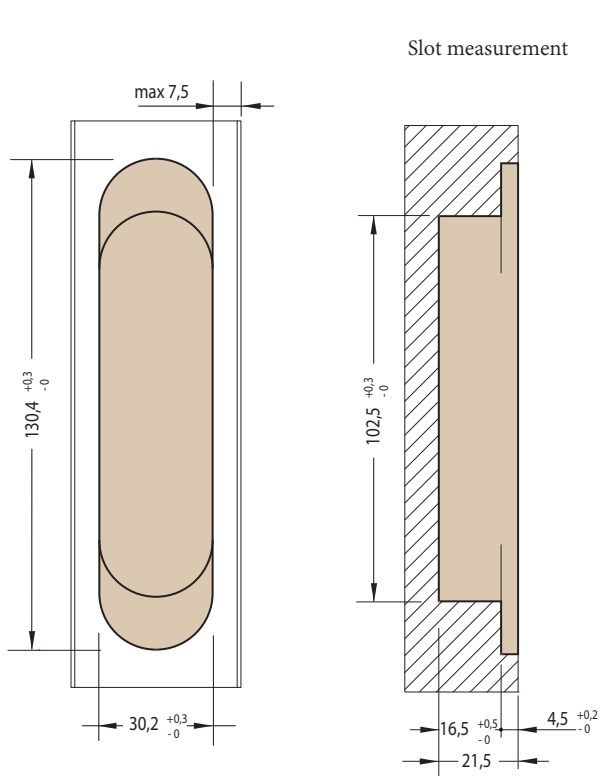

REVERSIBILITY

Reversible for doors from 35 mm to 45 mm thick

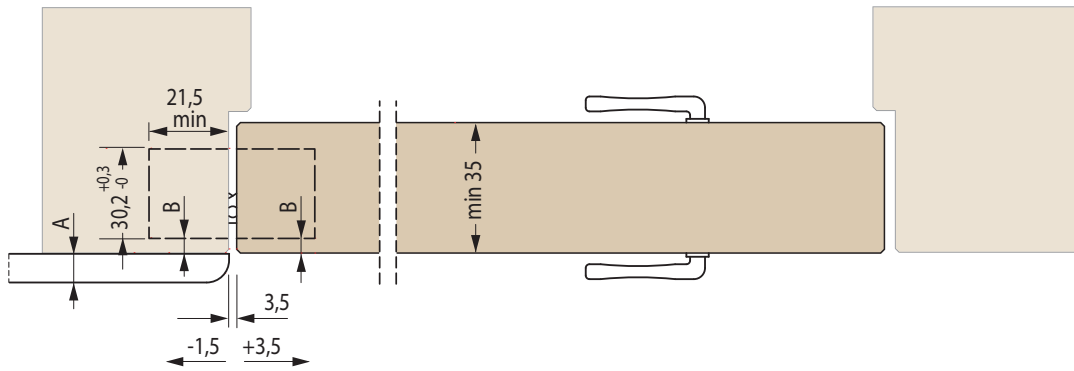
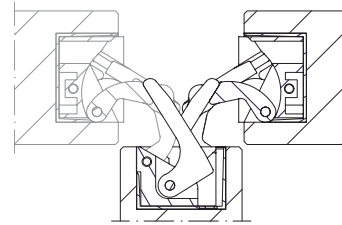

Door cross-section

A	B
15,5	2,5
14,5	3
13,5	3,5
12	4
10	4,5
8	5

1230 HINGE LOAD CAPACITY CHART

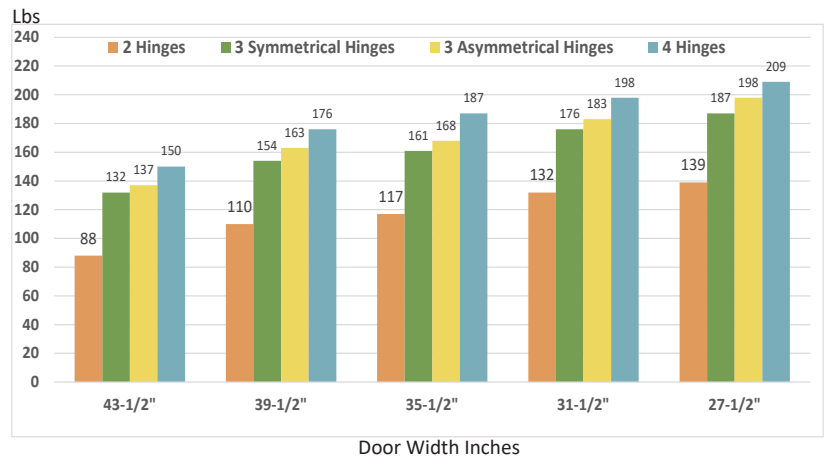
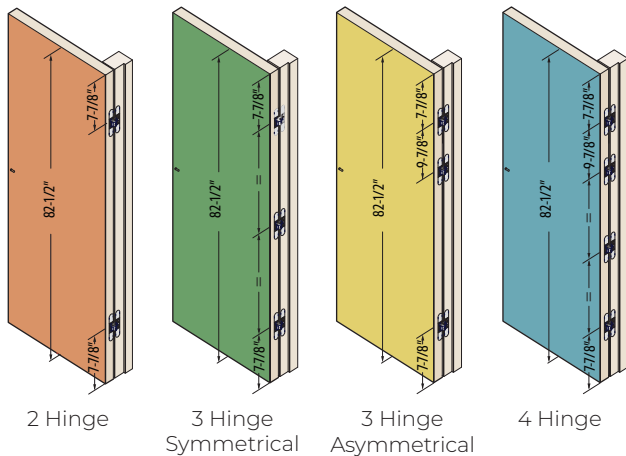

3D Invisible Hinge

1430

128 x 22 mm

MAINTENANCE**FREE**

- Manufactured in Zinc
- Suitable for doors of 28 mm min. thickness
- Total Length of 128 mm
- Only 21 mm of depth
- 3D adjustments with one simple tool
- Load capacity up to 132 lbs / 60 kg with 3 hinges
- Screws and instructions included

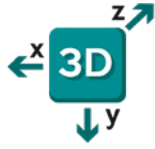
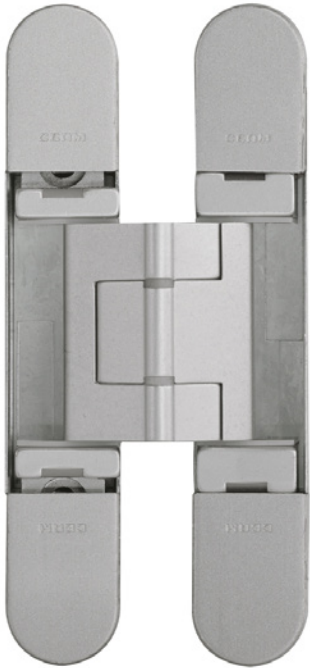

Item Number	Description	Packed
C1430SIL	3D Invisible Hinge 128 x 22 mm Silver Painted	3 / Box
C1430NK	3D Invisible Hinge 128 x 22 mm Nickel Plated	3 / Box
C1430BLK	3D Invisible Hinge 128 x 22 mm Matte Black Painted	3 / Box
C1430SNI**	3D Invisible Hinge 128 x 22 mm Satin Nickel Plated	3 / Box
C1430BBR**	3D Invisible Hinge 128 x 22 mm Brushed Bronze	3 / Box
C1130FIX	1430 Series Routing Fixture	1 / Box
C1430TEMP	1430 Series Inserts for Routing Fixtures	1 Set / Box

**Special order color / Item

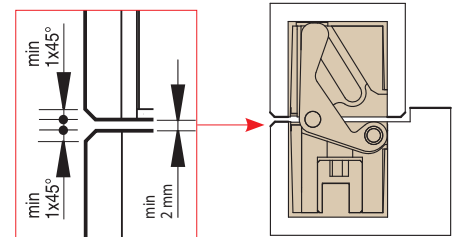
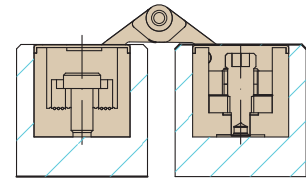
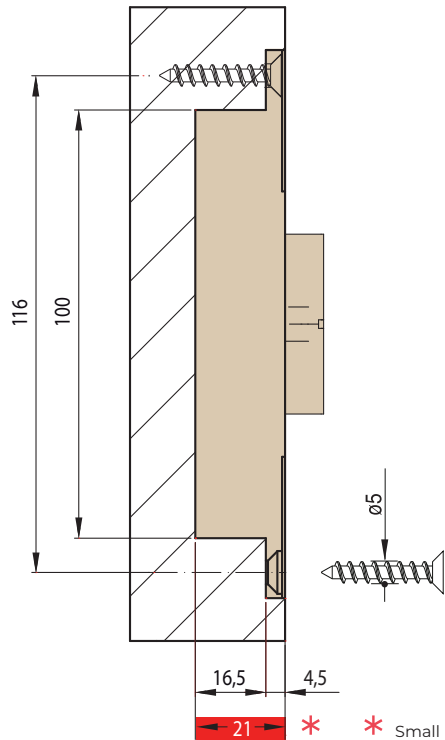
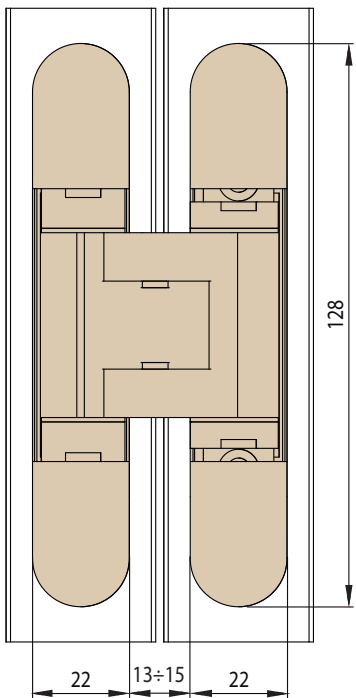

PMI recommends using the height adjustment side on the door and the depth adjustment on the frame. Make sure to keep the same adjustment type on the same side.

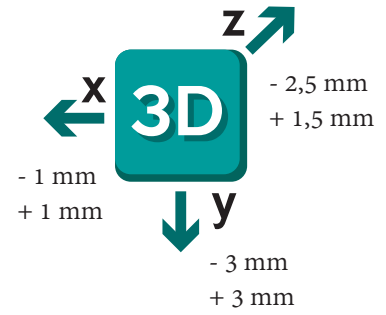
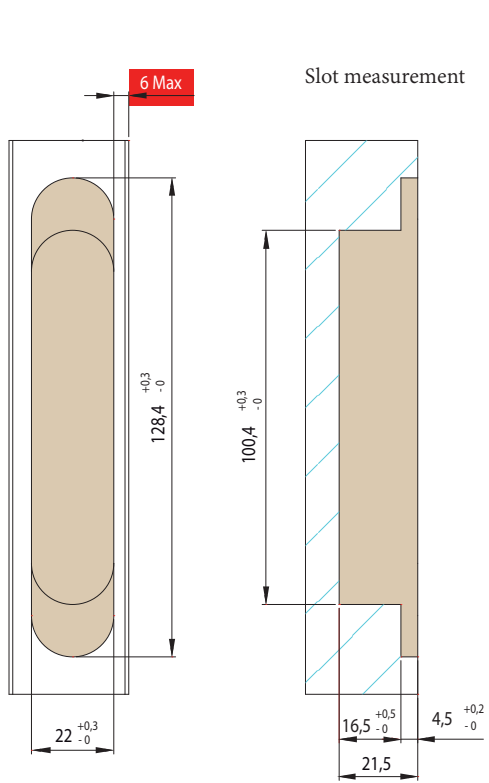

REVERSIBILITY

Reversible for doors from 28 mm to 34 mm thick

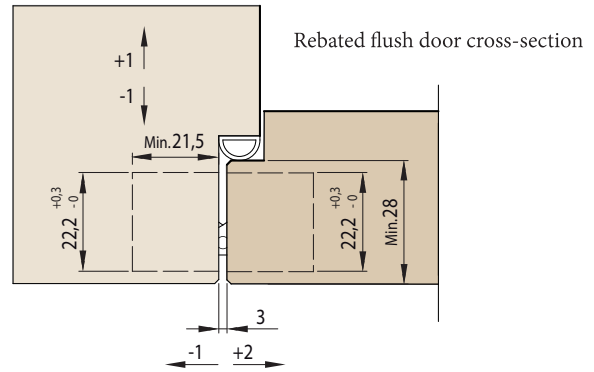
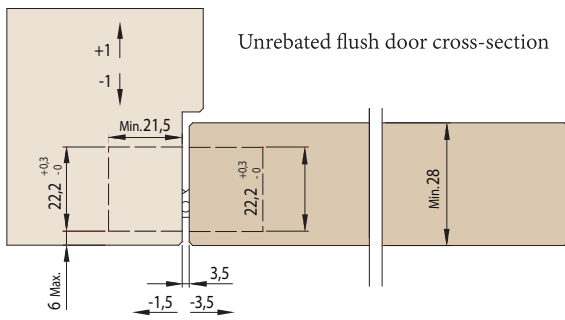
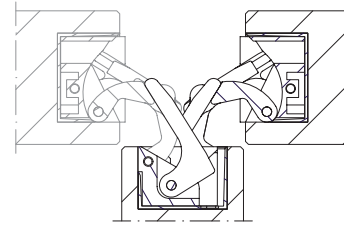

1430 HINGE LOAD CAPACITY CHART

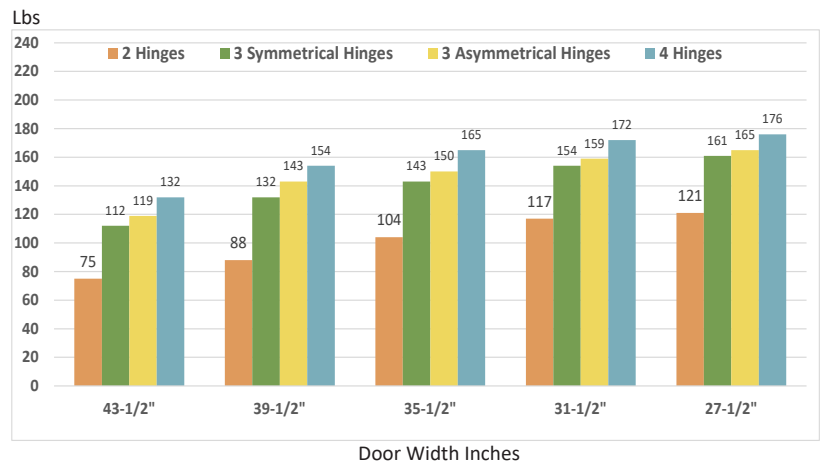
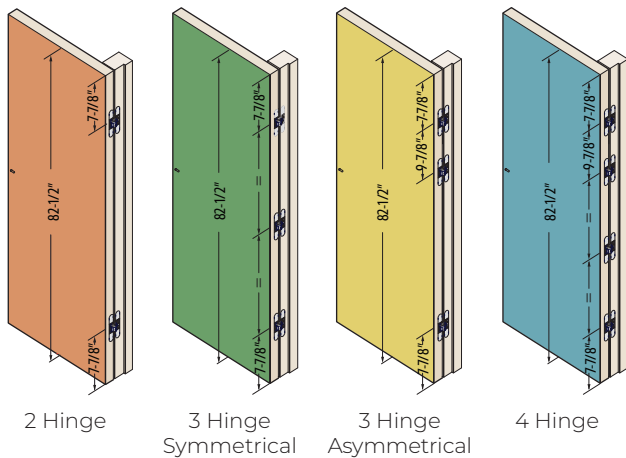

3D Invisible Hinge

1431
180 x 32 mm

MAINTENANCEFREE

- Manufactured in Zinc
- Suitable for doors of 38 mm min. thickness
- Total Length of 180 mm
- Only 29 mm of depth
- 3D adjustments with one simple tool
- Load capacity up to 331 lbs / 150 kg with 3 hinges
- Screws and instructions included

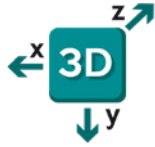
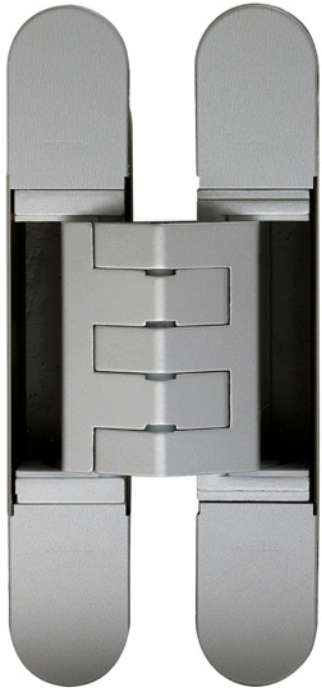

Item Number	Description	Packed
C1431SIL	3D Invisible Hinge 180 x 32 mm Silver Painted	3 / Box
C1431NK	3D Invisible Hinge 180 x 32 mm Nickel Plated	3 / Box
C1431BLK	3D Invisible Hinge 180 x 32 mm Matte Black Painted	3 / Box
C1431WHT**	3D Invisible Hinge 180 x 32 mm White Varnished	3 / Box
C1431SNI**	3D Invisible Hinge 180 x 32 mm Satin Nickel Plated	3 / Box
C1431BBR**	3D Invisible Hinge 180 x 32 mm Brushed Bronze	3 / Box
C1431BR**	3D Invisible Hinge 180 x 32 mm Polished Brass	3 / Box
C1431/1432FIX	1431 / 1432 / 1432W Series Routing Fixture	1 / Box
C1431TEMP	1431 Series Inserts for Routing Fixtures	1 Set / Box

**Special order color / Item

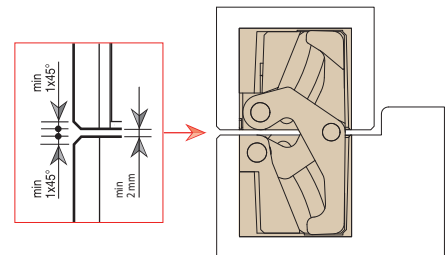
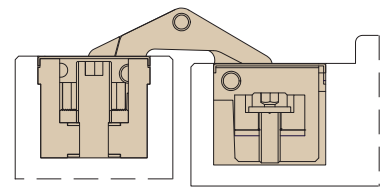
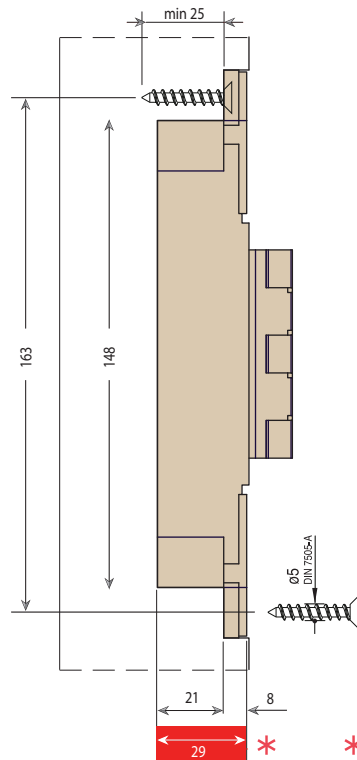
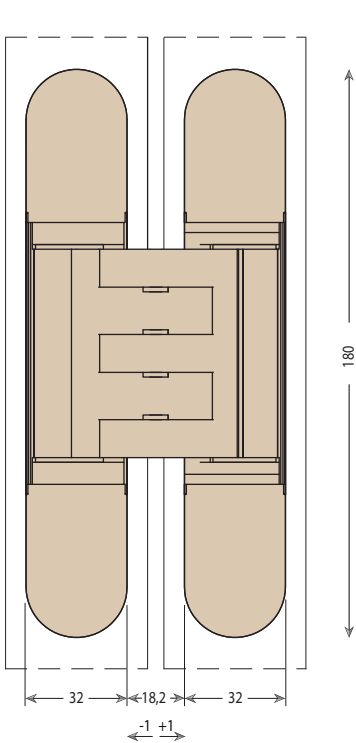

PMI recommends using the height adjustment side on the door and the depth adjustment on the frame. Make sure to keep the same adjustment type on the same side.

* Small Routing Depth

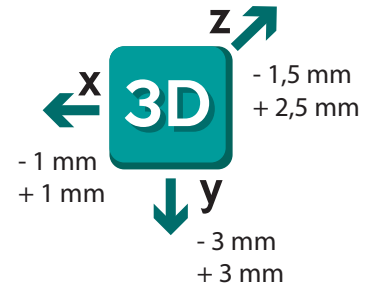
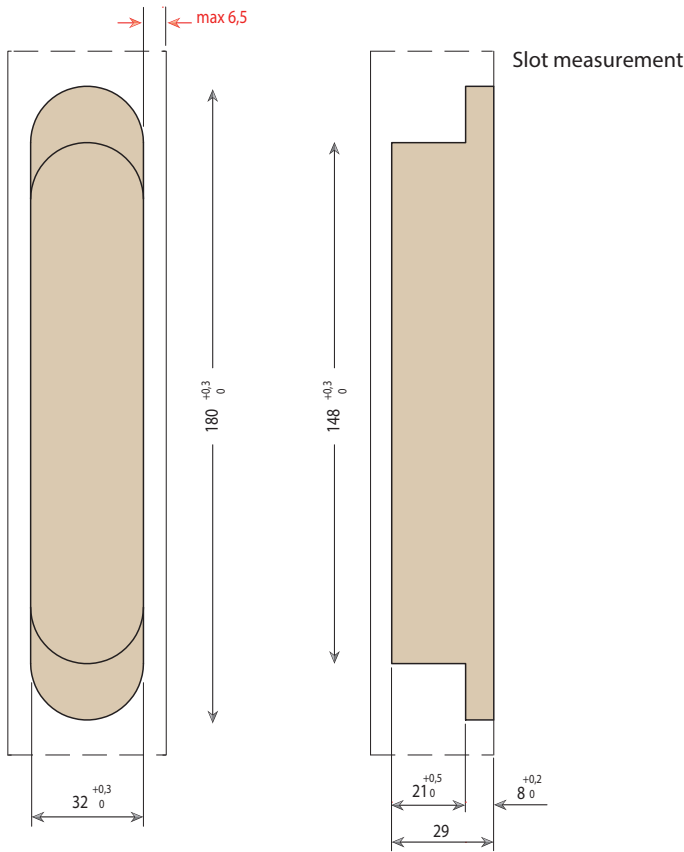

REVERSIBILITY
Reversible for doors from 38 mm to 45 mm thick

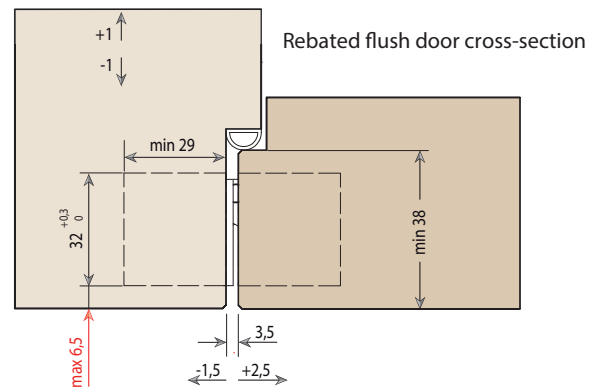
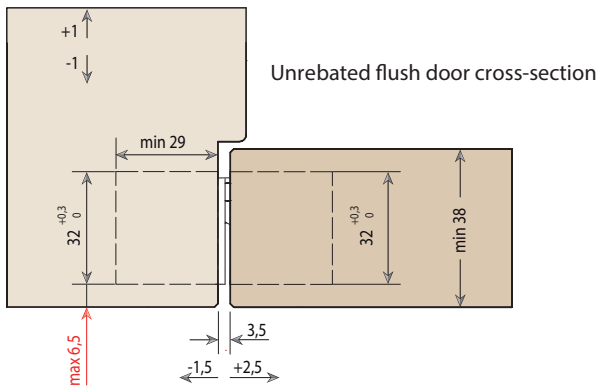
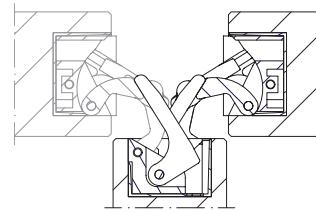

1431 HINGE LOAD CAPACITY CHART

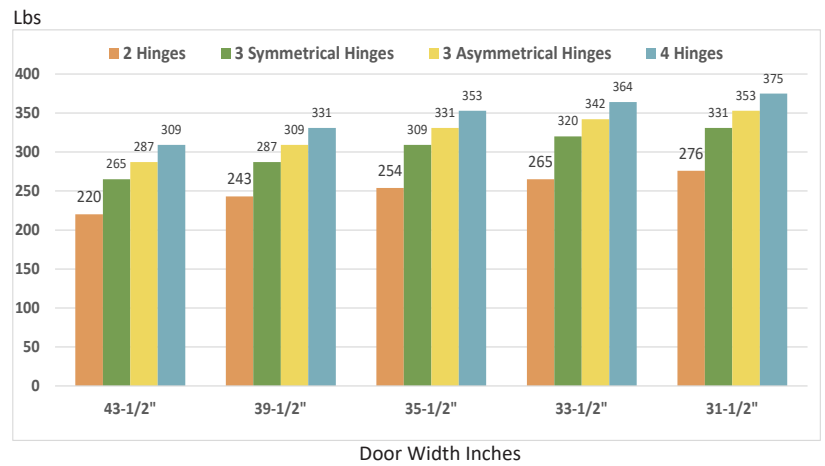
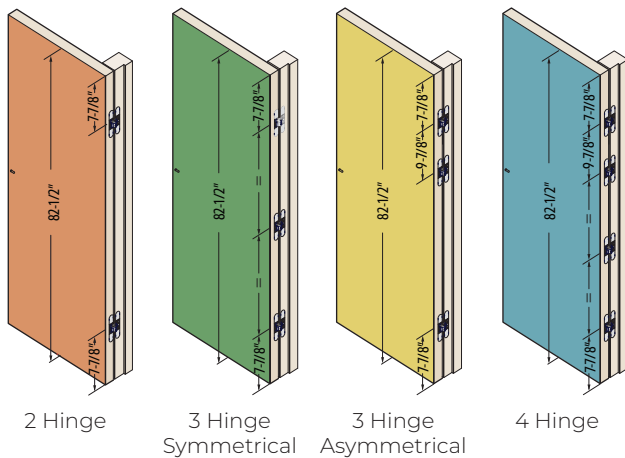

3D Invisible Hinge

1432
230 x 32 mm

MAINTENANCEFREE

- Manufactured in Zinc and Aluminum
- Suitable for doors of 38 mm min. thickness
- Total Length of 230 mm
- Only 32 mm of depth
- 3D adjustments with one simple tool
- Load capacity up to 452 lbs / 205 kg with 3 hinges
- Screws and instructions included

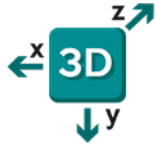

Item Number	Description	Packed
C1432SIL	3D Invisible Hinge 230 x 32 mm Silver Painted	3 / Box
C1432NK	3D Invisible Hinge 230 x 32 mm Nickel Plated	3 / Box
C1432BLK	3D Invisible Hinge 230 x 32 mm Matte Black Painted	3 / Box
C1432SNI**	3D Invisible Hinge 230 x 32 mm Satin Nickel Plated	3 / Box
C1432BBR**	3D Invisible Hinge 230 x 32 mm Brushed Bronze	3 / Box
C1432BR**	3D Invisible Hinge 230 x 32 mm Polished Brass	3 / Box
C1431/1432FIX	1431 / 1432 / 1432W Series Routing Fixture	1 / Box
C1432TEMP	1432 Series Inserts for Routing Fixtures	1 Set / Box

**Special order color / Item

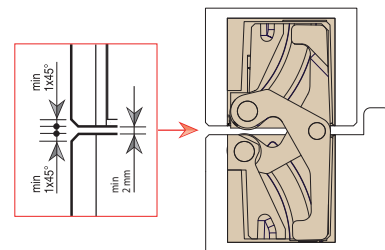
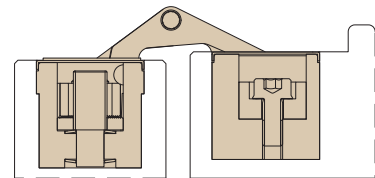
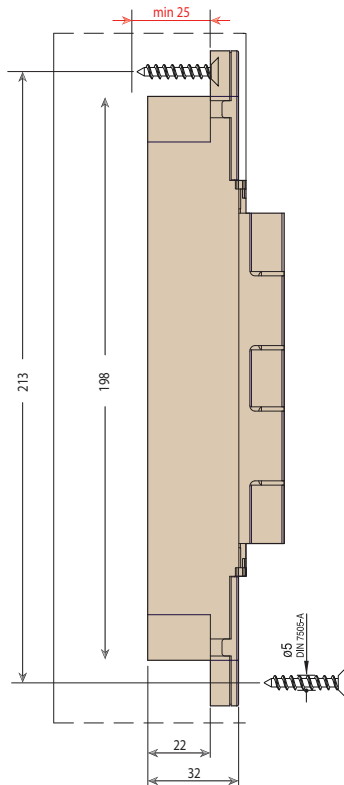
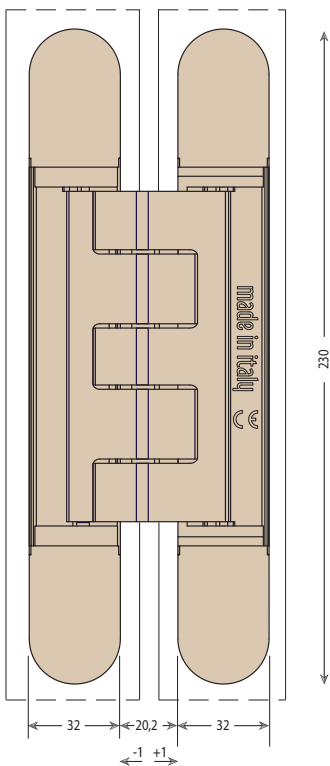

PMI recommends using the height adjustment side on the door and the depth adjustment on the frame. Make sure to keep the same adjustment type on the same side.

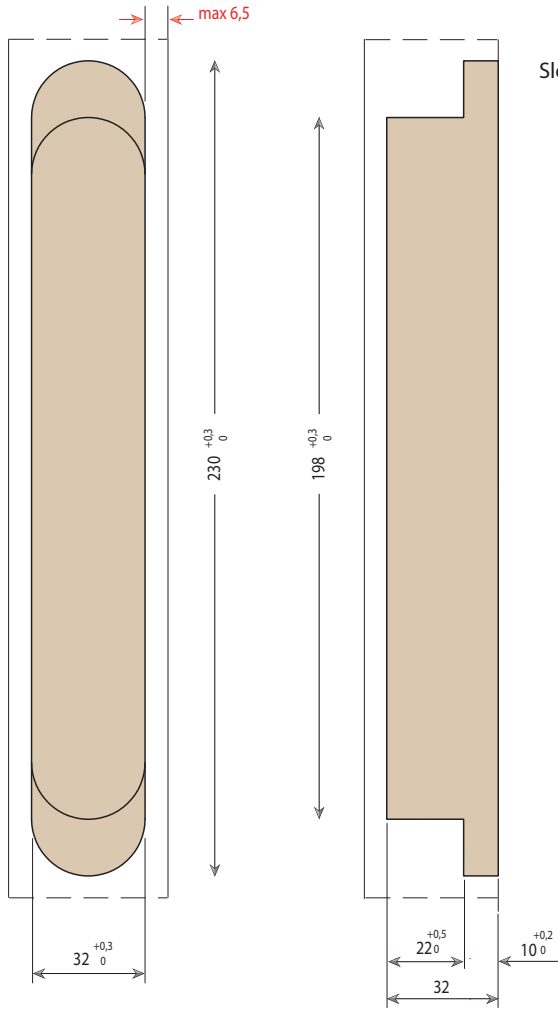

Slot measurement

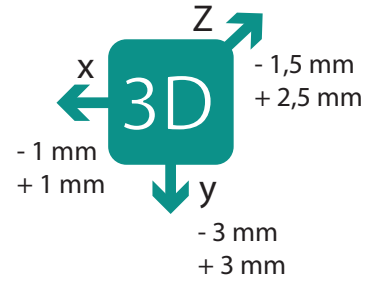

REVERSIBILITY

Reversible for doors from 38 mm to 45 mm thick

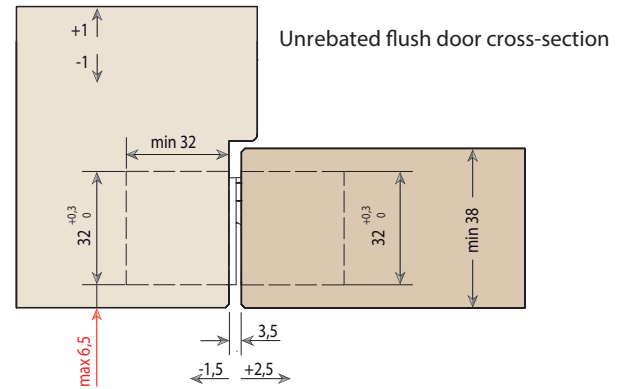
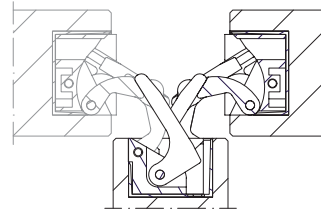

1432 HINGE LOAD CAPACITY CHART

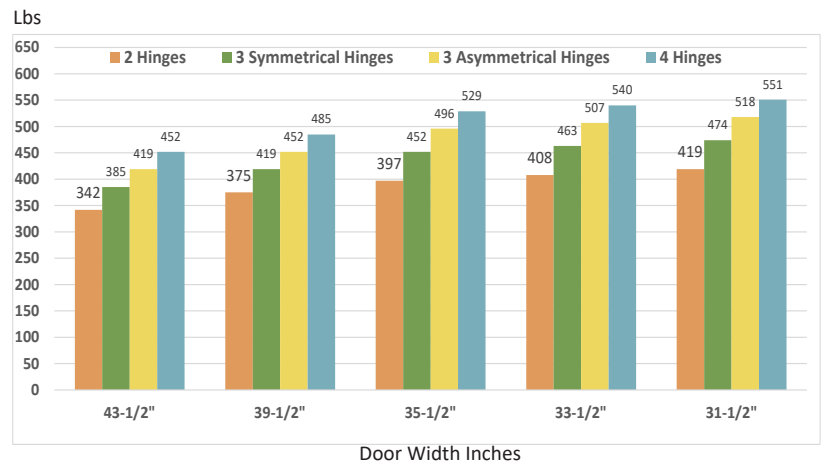
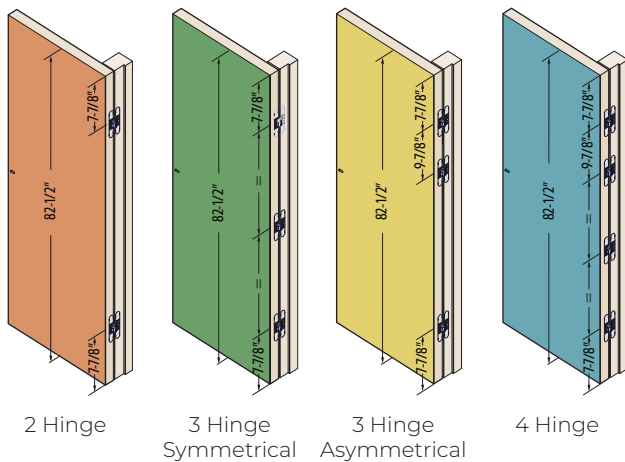

3D Invisible Hinge

1432W
230 x 32 mm

MAINTENANCEFREE

- Manufactured in Zinc
- Suitable for doors of 38 mm min. thickness
- Total Length of 230 mm
- Only 32 mm of depth
- 3D adjustments with one simple tool
- Load capacity up to 408 lbs / 185 kg with 3 hinges
- Screws and instructions included

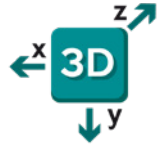

Item Number	Description	Packed
C1432SIL-W	3D Invisible Hinge 230 x 32 mm Silver Painted	3 / Box
C1432NK-W	3D Invisible Hinge 230 x 32 mm Nickel Plated	3 / Box
C1432BLK-W	3D Invisible Hinge 230 x 32 mm Matte Black Painted	3 / Box
C1432SNI-W**	3D Invisible Hinge 230 x 32 mm Satin Nickel Plated	3 / Box
C1432BBR-W**	3D Invisible Hinge 230 x 32 mm Brushed Bronze	3 / Box
C1432BR-W**	3D Invisible Hinge 230 x 32 mm Polished Brass	3 / Box
C1431/1432FIX	1431 / 1432 / 1432W Series Routing Fixture	1 / Box
C1432WTEMP	1432W Series Inserts for Routing Fixtures	1 Set / Box

**Special order color / Item

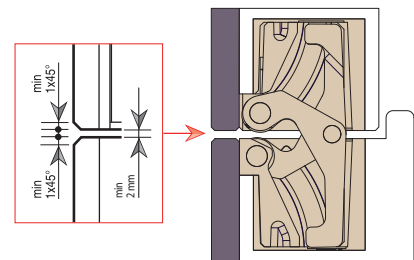
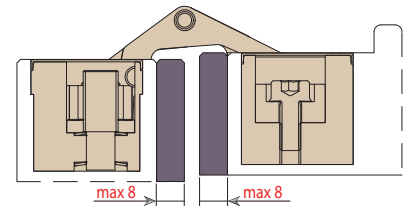
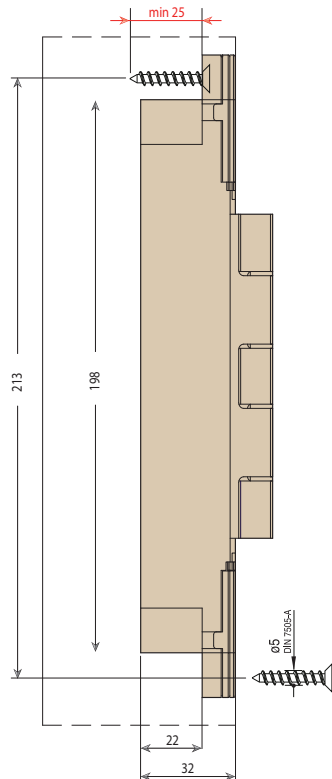
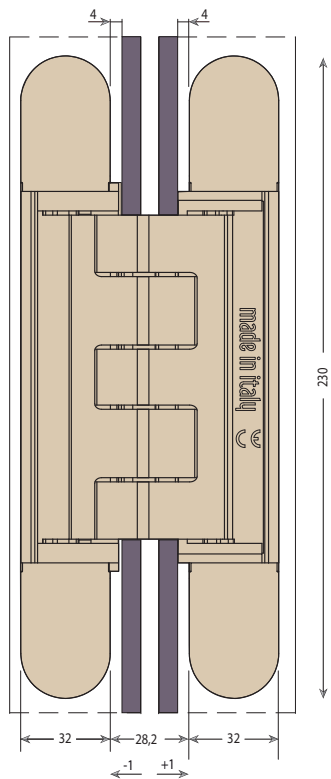

PMI recommends using the height adjustment side on the door and the depth adjustment on the frame. Make sure to keep the same adjustment type on the same side.

3D Invisible Hinge

929

76 x 14 mm

MAINTENANCE**FREE**

- Manufactured in Zinc and Fiberglass
- The first Ceam 3D hinge for cabinets
- Suitable for doors of 18 mm (3/4") min. thickness
- Total Length of 76 mm
- Only 15 mm of depth
- 3D adjustments with one simple tool
- Load capacity up to 35 lbs / 16 kg with 3 hinges
- Screws and instructions included

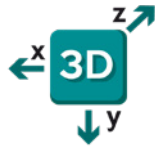

Routing template available



Item Number	Description	Packed
C929NK	3D Invisible Hinge 76 x 14 mm Nickel Plated	3 / Box
C929BLK	3D Invisible Hinge 76 x 14 mm Matte Black Painted	3 / Box
C929SIL**	3D Invisible Hinge 76 x 14 mm Silver	3 / Box
C929WHT**	3D Invisible Hinge 76 x 14 mm White Painted	3 / Box
C929TEMP	Routing Fixture/Template	3 / Box
C929TEMP-2	(x2) Routing Fixture/Template with 2 Linking blocks and 1 connecting rod	3 / Box

**Special order color / Item

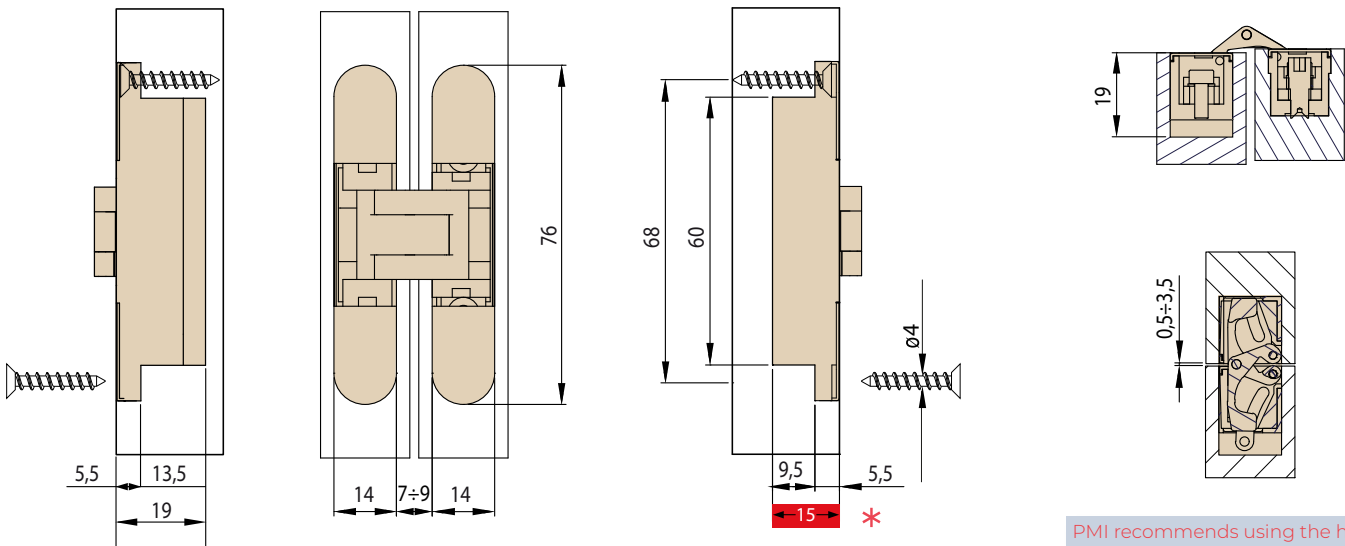

* Small Routing Depth

PMI recommends using the height adjustment side on the door and the depth adjustment on the frame. Make sure to keep the same adjustment type on the same side.

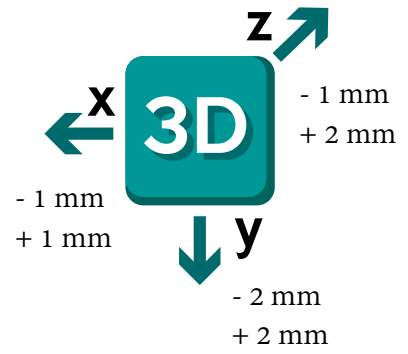
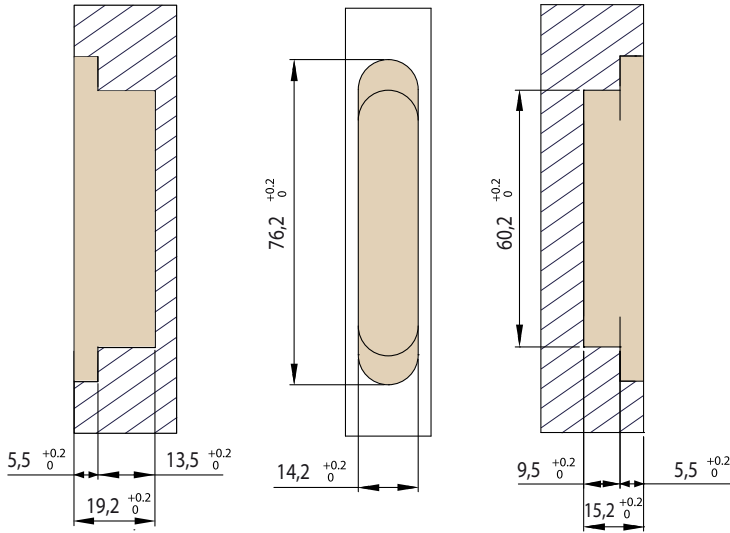

Slot measurement

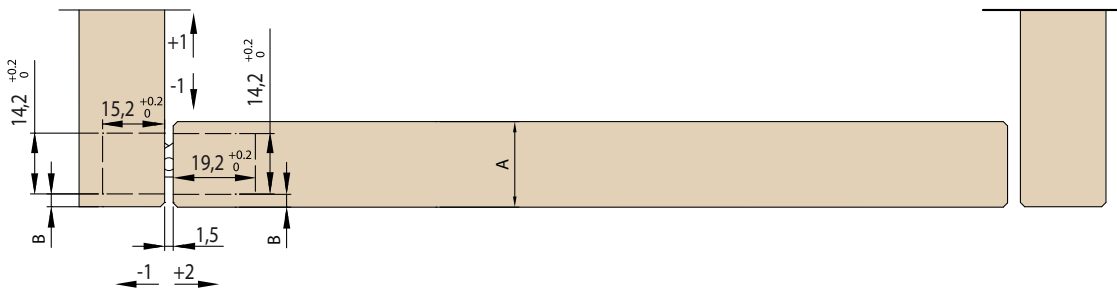

Cabinet cross-section with door inside the box

A	B
18	2
20	3

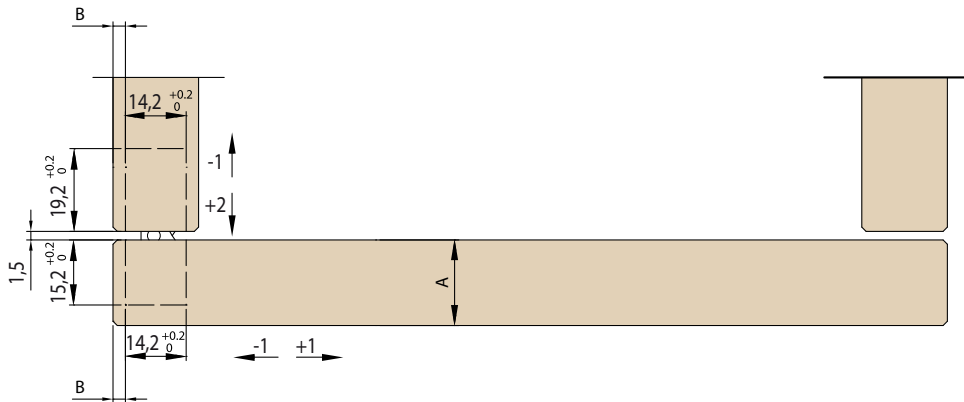

Cabinet cross-section with door outside the box

A	B
18	2
20	3

929 HINGE LOAD CAPACITY CHART

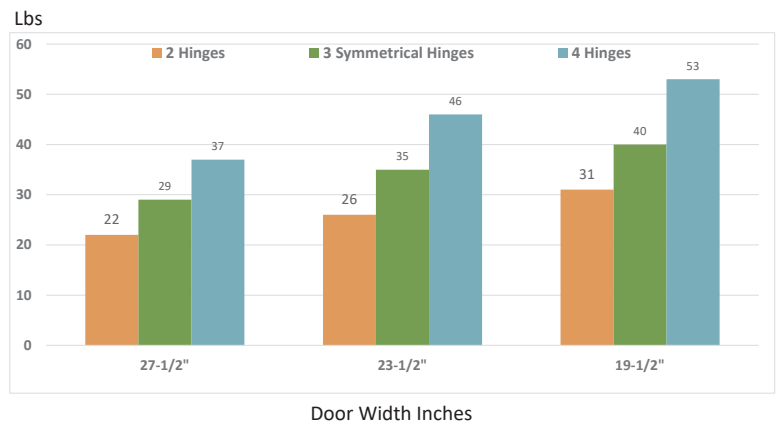
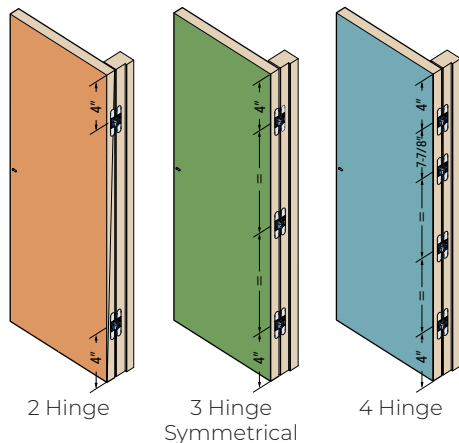

2010SS

89 x 25 mm

- Manufactured in #304 Stainless Steel and Nylon
- Suitable for doors of 31 mm min. thickness
- Total Length of 89 mm
- Only 27.3 mm of depth
- Load capacity up to 132 lbs / 60 kg with 3 hinges



#304

STAINLESS
STEEL

Item Number	Description	Packed
C2010SS	Invisible Hinge 89 x 25 mm Stainless Steel / Nylon	3 / Box

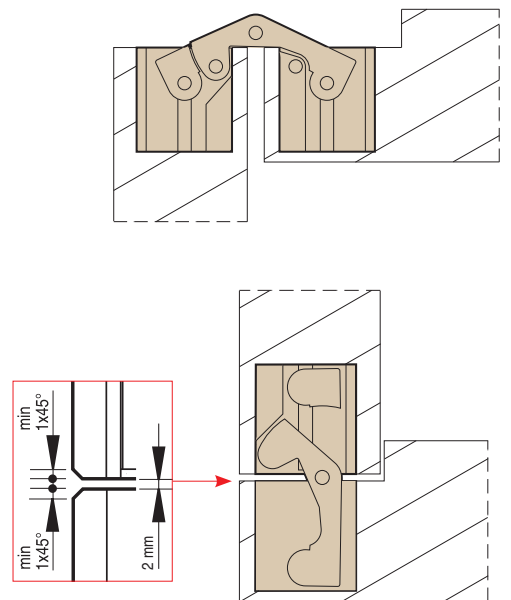
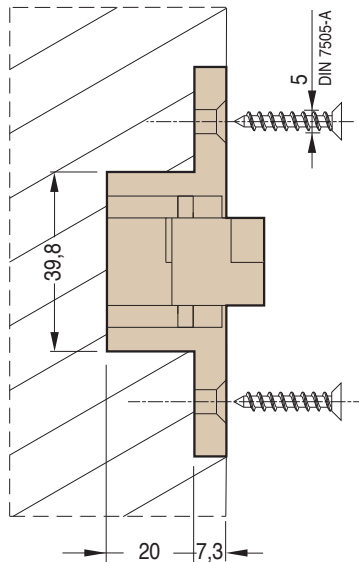
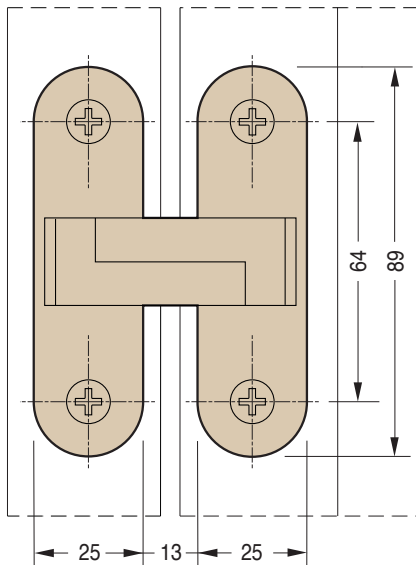

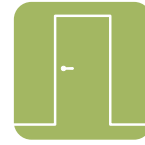
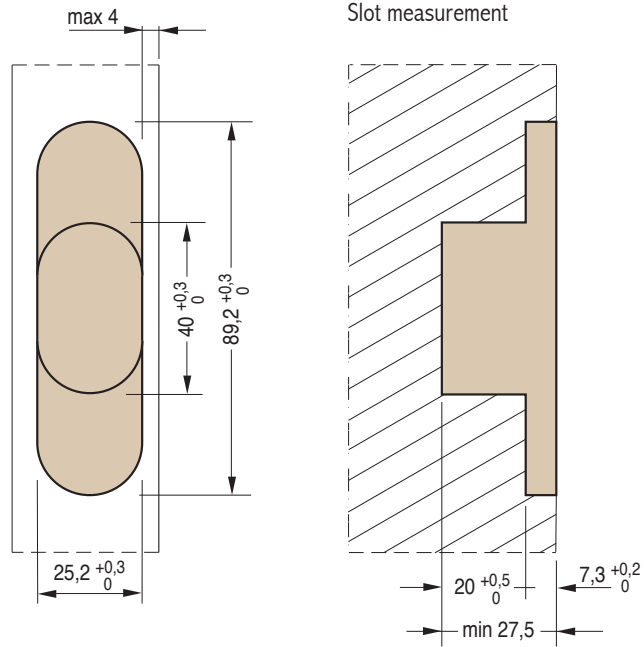

REVERSIBILITY

Reversible for doors from 31 mm to 33 mm thick Reversible

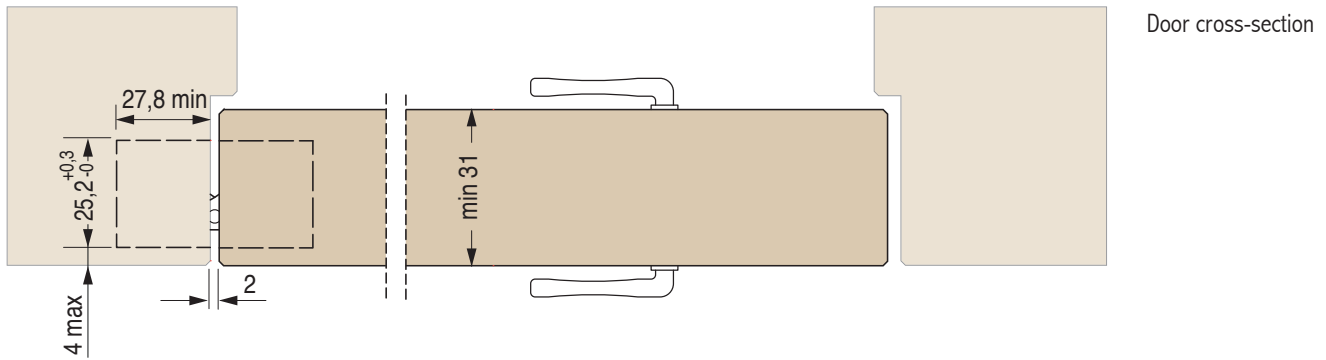
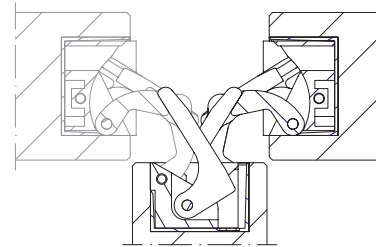

2010SS HINGE LOAD CAPACITY CHART

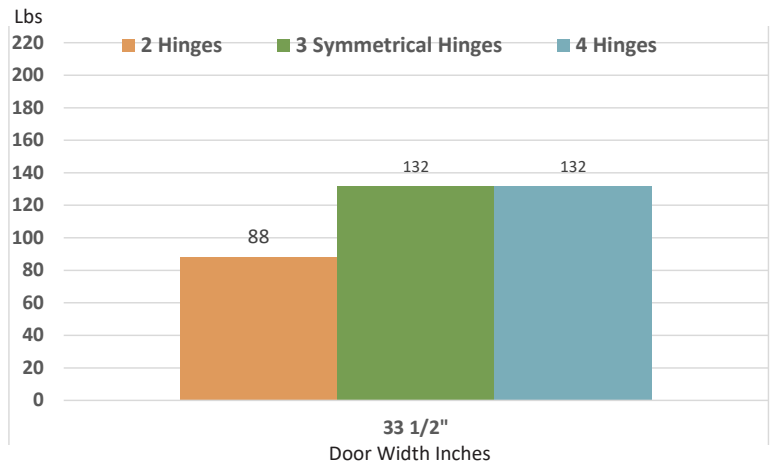
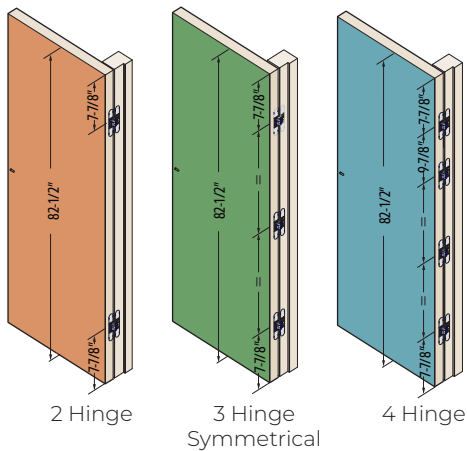

Routing Fixture

& Templates

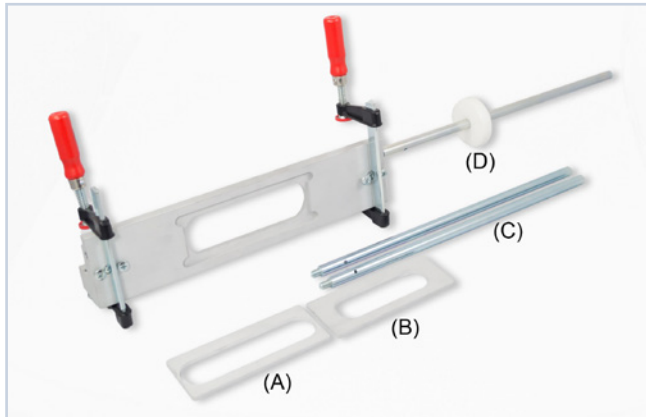

CEAM's routing template is specifically designed for manual pantographs, to easily create the slots for any invisible hinge model, using different inserts.



*Very important for the correct use and assembly of the insert. The reference is printed on the template and the code is printed on the same side of the inserts.

929 Template



The C929TEMP-2 template includes linking blocks and 24" rod that adjusts to lock both templates into position to drill with even spacings every time.

The Routing template, which comprises a frame and 2 insertions, enables implementation of 2 slots for the invisible hinges and is made of 5 mm thick aluminum plates.

The strength of the materials guarantees precise execution of the slots with a manual pantograph. All manual pantographs are made to fit 10 mm diameter cutters and 5/8" (16 mm) external collet.

Examples for router tools in using Ceam Hinges:

- 5/8" router bushing with 10 mm router bit.
(recommended: Powertec 71166 bushing with Amana 45417 bit or CMT 811.600.11 bit)
- 51/64" router bushing with 9/16" router bit.
(recommended: Powertec 71352 bushing with Whiteside 1075 bit)
- For 929 Template only: 5/8" Router bushing with a 1/2" mortising bit.

2 types of insertions (easily replaceable) are used: one **(A)** to execute the butt slots and the other **(B)** for the internal depth slot. The extension arms **(C)**, with a nylon ring **(D)**, establish the desired distance between slots on the door - both left and right - and on the frame.

Fixture & Template Guide

Hinge Style	Items No.	Description	Packed
1130SS	C1130FIX	Routing Fixture	1 / Box
	C1130TEMP	Inserts for Routing Template	1 Set / Box
1131	C1131/1230FIX	Routing Fixture	1 / Box
	C1131TEMP	Inserts for Routing Template	1 Set / Box
1230	C1131/1230 FIX	Routing Fixture	1 / Box
	C1230TEMP	Inserts for Routing Template	1 Set / Box
1430	C1130FIX	Routing Fixture	1 / Box
	C1430TEMP	Inserts for Routing Template	1 Set / Box
1431	C1431/1432 FIX	Routing Fixture	1/Box
	C1431TEMP	Insert for Routing Template	1 Set / Box
1432	C1431/1432 FIX	Routing Fixture	1/Box
	C1432TEMP	Insert for Routing Template	1 Set / Box
1432W	C1431/1432 FIX	Routing Fixture	1/Box
	C1432WTEMP	Insert for Routing Template	1 Set / Box
929	C929TEMP	Routing Fixture/Template	1/Box
	C929TEMP-2	(x2) Routing Fixture/Template with 2 Linking blocks and 1 connecting rod	1/Box

Frame Fixing Plate

For Metal Doors

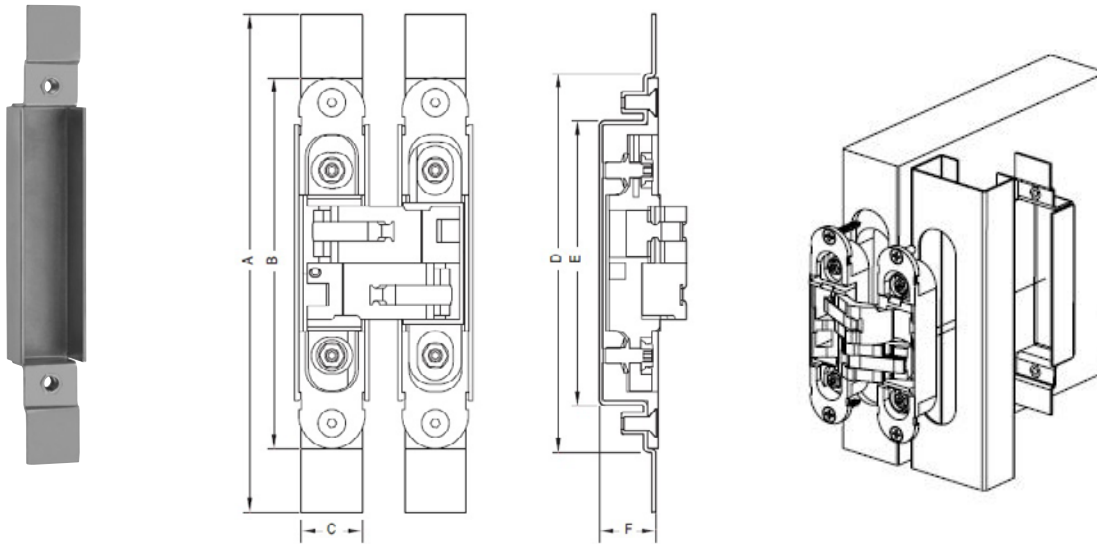

Item Number	Description	A	B	C	D	E	F	Packed
1130FFP	1130 Series Frame Fixing Plate, Steel Galv.	180	134	22	137	103	21	1 / Box
1131FFP	1131 Series Frame Fixing Plate, Steel Galv	198	161	30	164	133	31	1 / Box
1230FFP	1230 Series Frame Fixing Plate, Steel Galv	180	130	29	133	105	21	1 / Box

Wall Fixing Plate

For Wood Doors

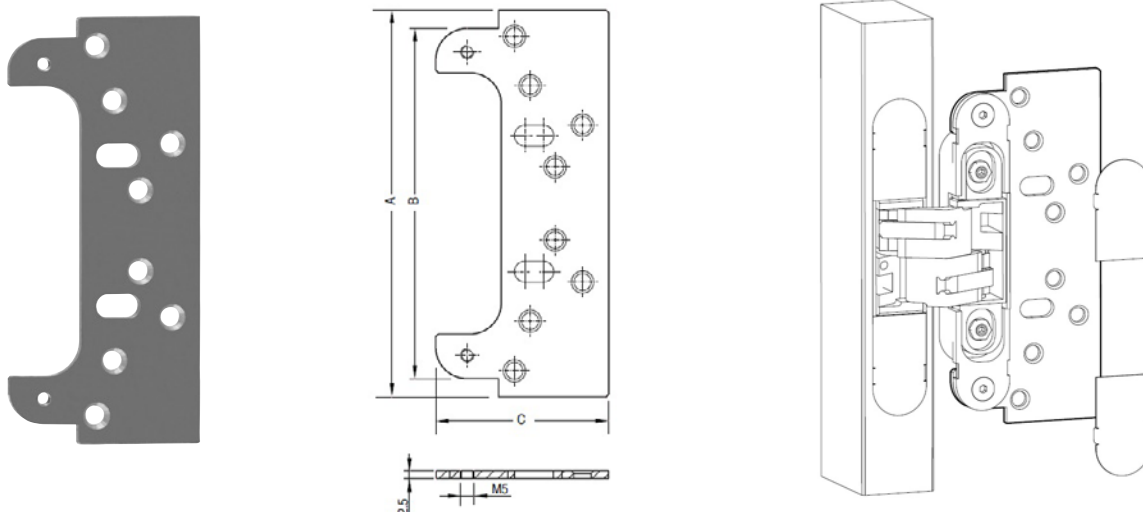

Item Number	Description	A	B	C	D	Packed
1130WFP	1130 Series Wall Fixing Plate, Steel Galv.	148	134	134	2.5	1 / Box
1131WFP	1131 Series Wall Fixing Plate, Steel Galv	180	166	74	3	1 / Box
1230WFP	1230 Series Wall Fixing Plate, Steel Galv	136	136	70	3	1 / Box



CONTACT INFO

1255 South Park Dr.
Kernersville, NC 27284 USA

Tel. 336-996-7774
Fax 336-996-1812
Toll Free 800-222-6941

E-mail: info@petermeier.com
www.petermeier.com