

Bosch Wired Wall Thermostat

For use with Bosch Split-Type Ductless Air Conditioner / Heat Pump



BOSCH

User Manual



Table of Contents

1	Key to Symbols and Safety Instructions	4
1.1	Key to Symbols	4
2	Remote Controller Specifications	4
3	Operation of Buttons	5
4	Indicators on LCD	6
5	Installation	7
5.1	Dimensions	7
5.2	Wiring	7
5.3	Remove Front Cover	8
5.4	Mount Back Plate	9
5.5	Battery Installation	9
5.6	Connect to Indoor Unit	9
5.7	Reattach the Cover of the Wired Wall Thermostat	10
5.8	Installation Guide for Wall Mounted Indoor Unit Only	10
6	Operation Guideline	12
6.1	Set Date and Time	12
6.2	Cooling/Heating/Fan Operation	12
6.3	Change Fan Speed	12
6.4	Follow Me Function (Wall Mounted Indoor Unit Only)	13
6.5	Child Lock	13
6.6	Key Pad Tone Setting	13
6.7	°F / °C Selection	13
6.8	Turbo Mode	13
6.9	Decorative Grille Automatic Lift Up/Down (works with 4-Way Cassette Indoor only)	13
6.10	Swing Function	14
6.11	Scheduling	15
6.12	Copy Existing Schedule	17
6.13	Delete Saved Schedule	18
6.13	Set Timer On or Off Function	19
6.14	Set Timer On and Off Function	19

1 Key to Symbols and Safety Instructions

1.1 Key to Symbols

Warnings



Warnings in this document are identified by a warning triangle printed against a grey background. Keywords at the start of a warning indicate the type and seriousness of the ensuing risk if measures to prevent the risk are not taken.

The following keywords are defined and can be used in this document:

- ▶ **DANGER** indicates a hazardous situation which, if not avoided, will result in death or serious injury.
- ▶ **WARNING** indicates a hazardous situation which, if not avoided, could result in death or serious injury.
- ▶ **CAUTION** indicates a hazardous situation which, if not avoided, could result in minor to moderate injury.
- ▶ **NOTICE** is used to address practices not related to personal injury.

Important information



This symbol indicates important information where there is no risk to people or property.

2 Remote Controller Specifications

	IDU Type	
	Wall Mounted	Cassette & Ducted
Model Name	BMS-WT1-XXX	BMS-WT2-XXX
Model #	8733953127	8733953128
Input Voltage	DC 5V	DC 12V
Environment (°F / °C)	23~110 / -5~43	

Table 1



Button design is based on a typical model and might be slightly different from the actual one you purchased, the actual shape shall prevail.



WARNING:

- ▶ This product can expose you to chemicals including Lead and Lead components, which are known to the State of California to cause cancer and birth defects or other reproductive harm. For more information go to www.P65Warnings.ca.gov.

3 Operation of Buttons

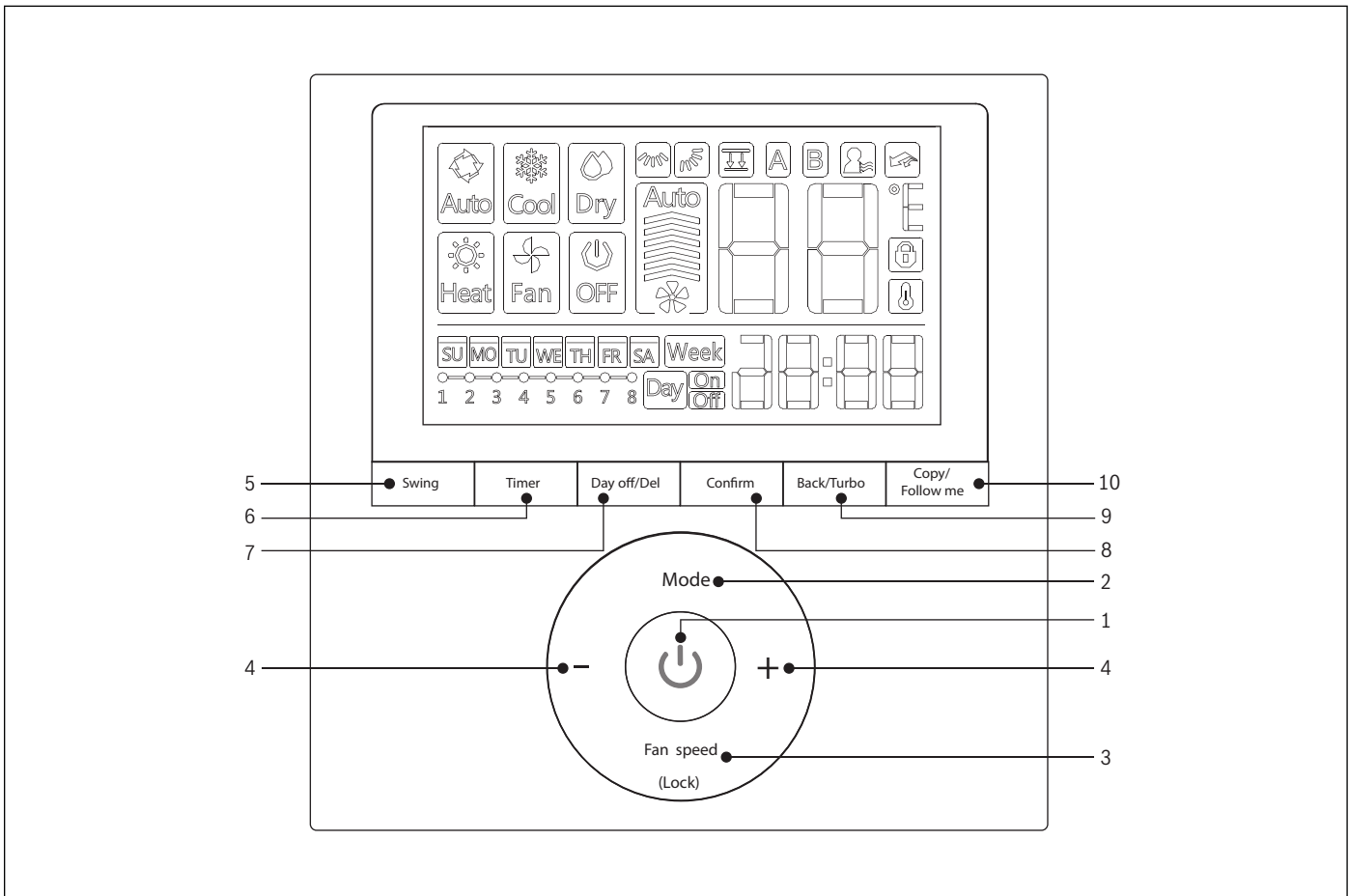

Figure 1

1. ON/OFF: Press this button to turn the system ON or OFF.

2. MODE: Change mode of operation.



3. FAN: Change fan speed.

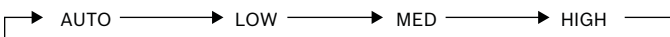

You can not switch the fan speed in AUTO or DRY mode

4. ADJUST: Used to adjust setting.

5. SWING: Adjust louver angle (Wall Mounted and Cassette type indoors only).

6. TIMER: Set up On/Off Timer, 7-Day schedule.

7. DAY OFF/DEL: Used to skip day during 7-Day scheduling or delete saved set up.

8. CONFIRM: Used to save setting change.

9. BACK/TURBO: To go back to previous page or select Turbo mode.

10. COPY/FOLLOW ME: Copy the setting or activate Follow Me function.

4 Indicators on LCD

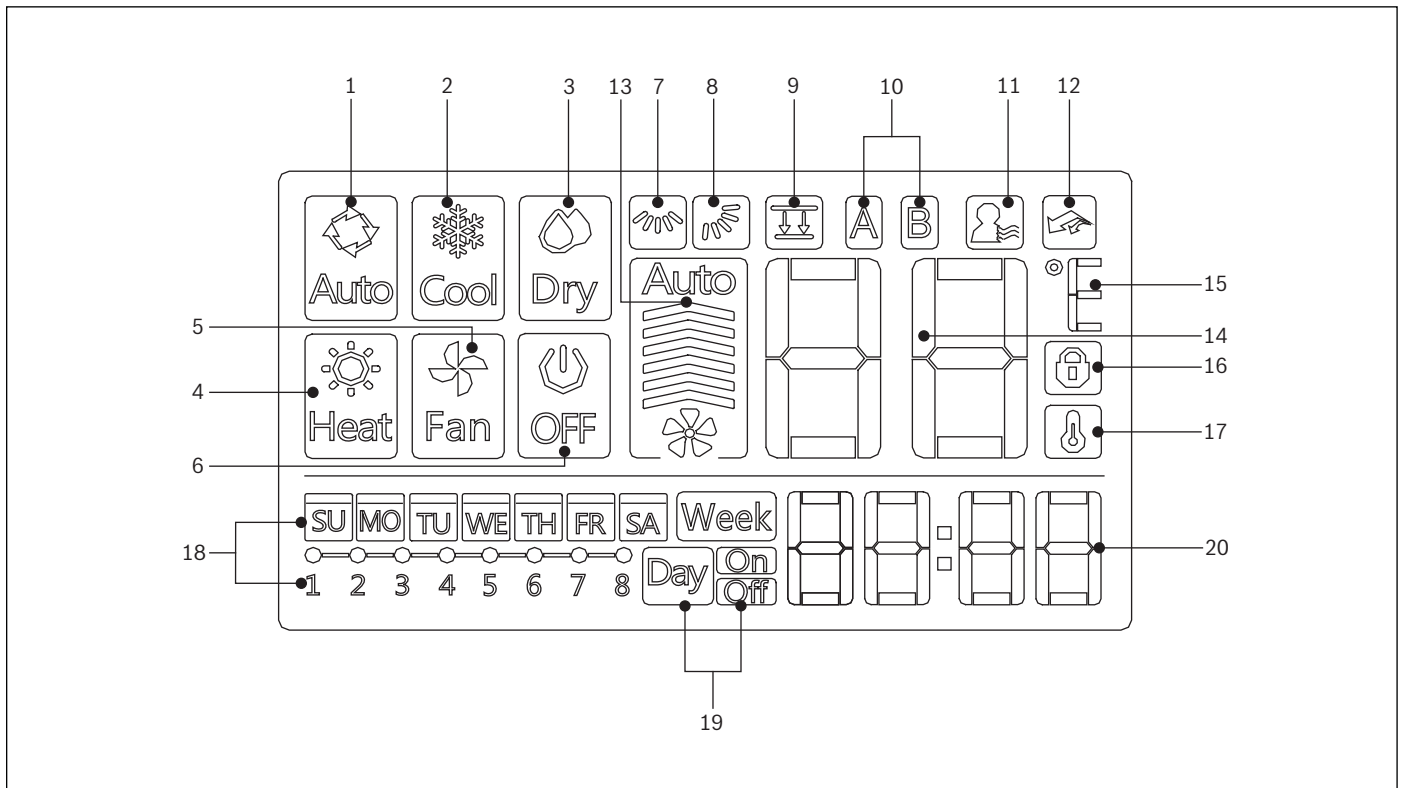

Figure 2

No.	Icon	Description
1	Auto	Operation Mode: Auto
2	Cool	Operation Mode: Cool
3	Dry	Operation Mode: Dry
4	Heat	Operation Mode: Heat
5	Fan	Operation Mode: Fan
6	Off	Operation Mode: Off
7	Fan Swing	Fan Swing Indicator: Left-Right (Not applicable)
8	Fan Swing	Fan Swing Indicator: Up-Down
9	Faceplate	Decorative Grille Automatic Lift Function (optional accessory required)
10	A & B	Unavailable function in N.A.
11	Follow Me	Follow Me Function Indicator
12	Turbo	Turbo Mode On Indicator
13	Fan Speed	Fan Speed Indicator (Lo-Med-Hi-Auto)
14	Temperature	Temperature Display
15	Unit	°C / °F Indicator
16	Lock	Child Lock Indicator
17	Room Temperature	Room Temperature Indicator
18	7-Day Schedule	Schedule Function Indicator
19	On / Off	On / Off Timer Display
20	Clock	Clock Display

Table 2

5 Installation

5.1 Dimensions

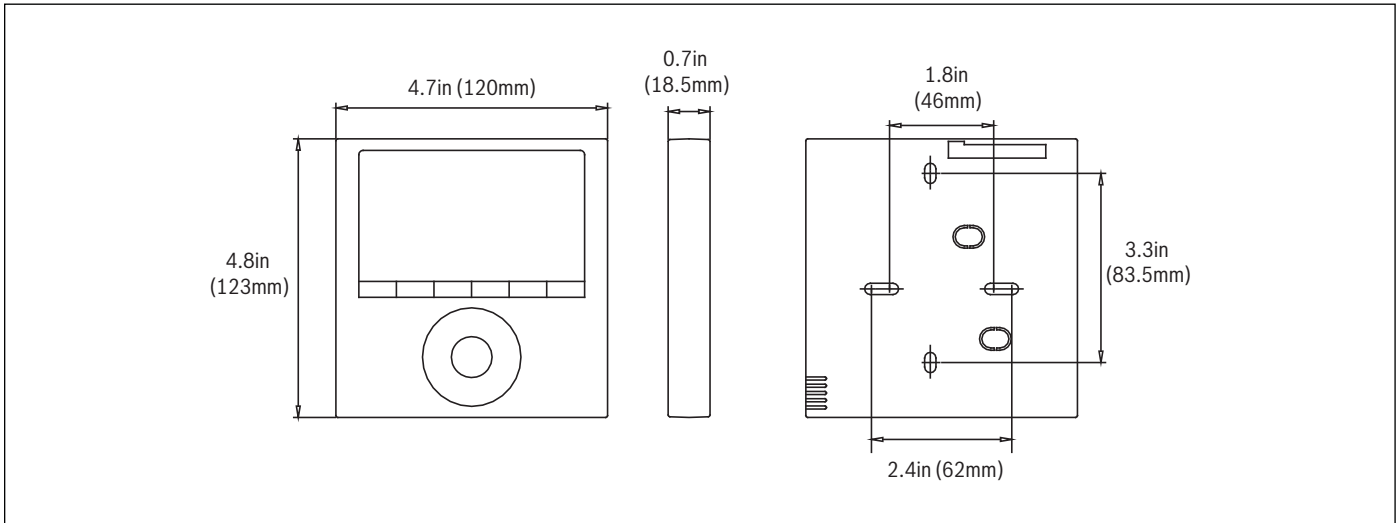

Figure 3

5.2 Wiring

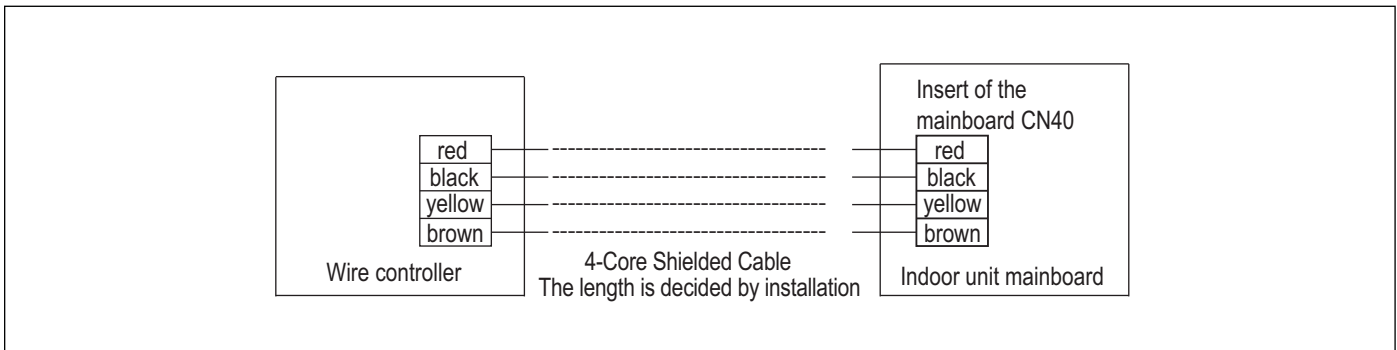

Figure 4

For Wall Mounted Indoor Units

Install the Adapter Board and the Display Board on the Wall Mounted indoor unit.

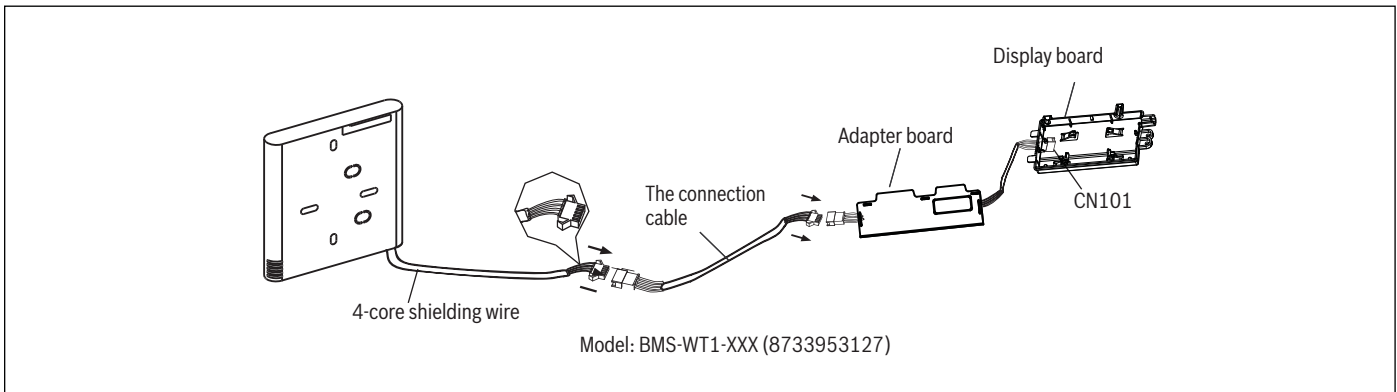

Figure 5

For 4-Way Cassette and Concealed Ducted Indoor Units

Figure 6



Do not install the wired wall thermostat where it can be affected by:

- ▶ Direct hot or cold air from ducts
- ▶ Drafts or dead spots behind doors and corners
- ▶ Direct sun light contact area

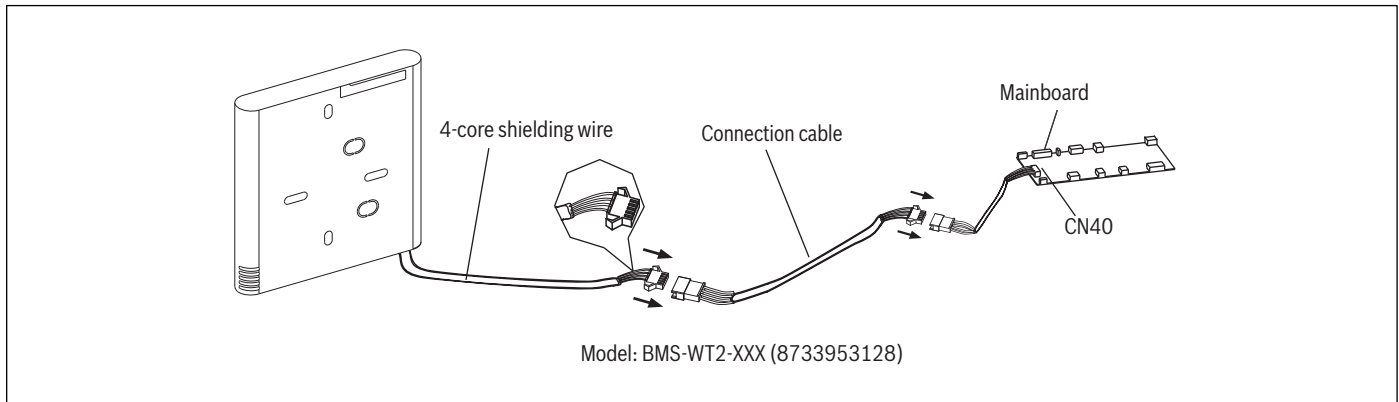
5.3 Remove Front Cover

1. Insert a screwdriver into the slots in the lower part of the wired wall thermostat (2 places).

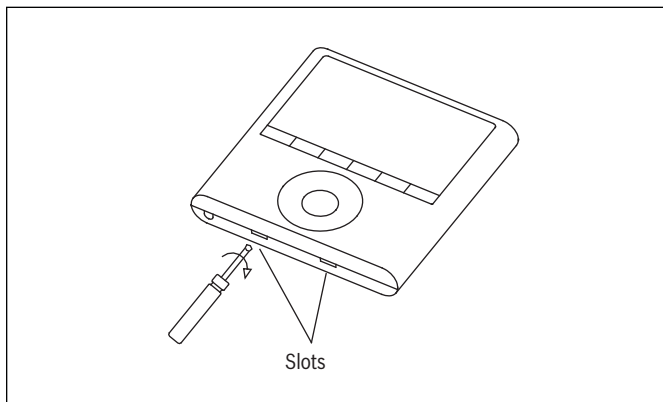

2. Remove the front cover.



The PCB is mounted in the upper part of the wired controller. Be careful not to damage the board with the screwdriver.

5.4 Mount Back Plate

1. For surface mounting, install back plate on the wall with the 3 screws (M4x20) and plugs.

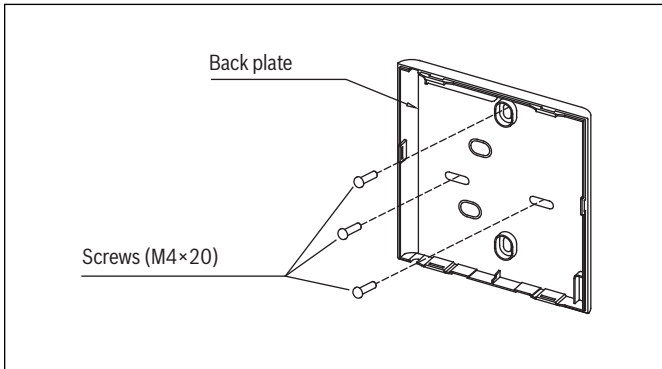

Figure 7

2. For switch box mounting, install the back plate on the switch box with 2 screws (M4x25) and fasten it on the wall with 1 screw (M4x20).

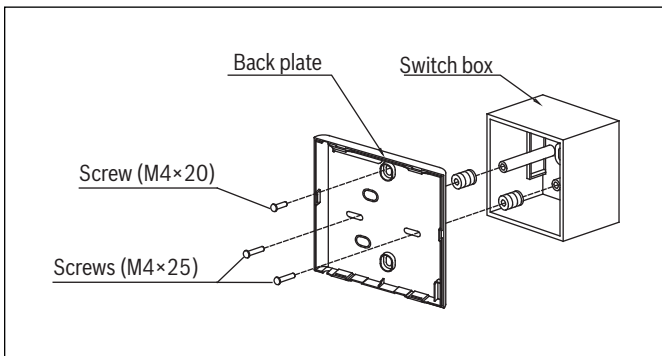

Figure 8

i Place on a flat surface. Over-tightening screws may damage back plate of the wired wall thermostat.

5.5 Battery Installation

1. Place the battery in the unit and ensure the positive side of the battery is in accordance with the polarity markings.

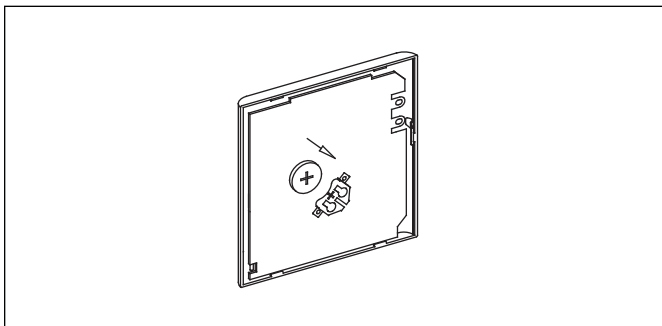

Figure 9

2. Set the correct time before operating. Batteries in the wired controller can maintain the correct time during a power failure. When the power is restored and the displayed time is not correct, replace the battery.

5.6 Connect to Indoor Unit

There are three methods:

Method 1: from back

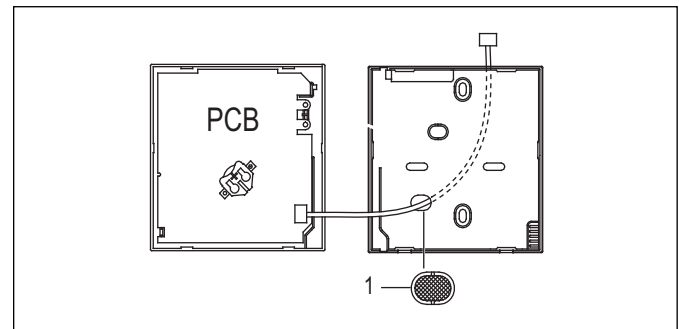

Figure 10

Method 2: from bottom

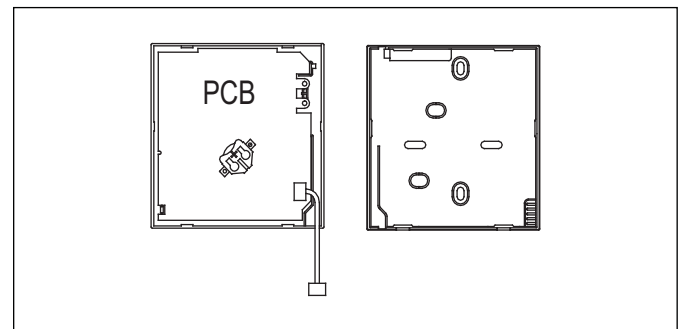

Figure 11

Method 3: from top

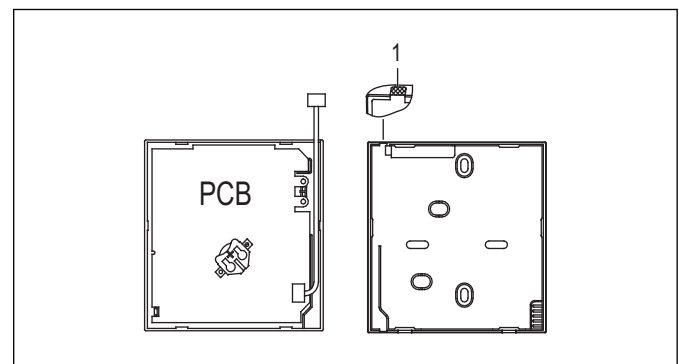

Figure 12

Knock-out the part for the wiring to pass through with a nipper tool.

i DO NOT allow water to enter the wired wall thermostat. Use the trap and putty to seal the wires.

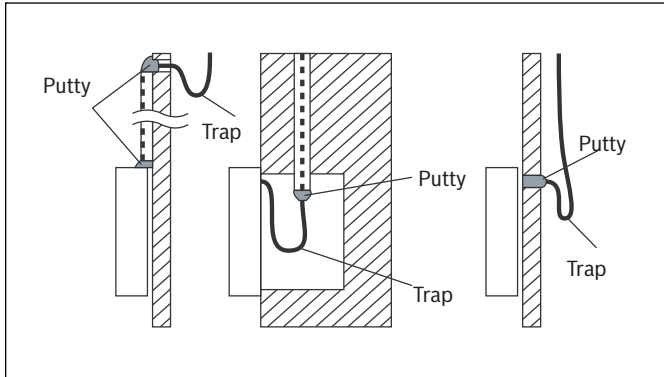

Figure 13

5.7 Reattach the Cover of the Wired Wall Thermostat

1. Avoid clamping during installation.

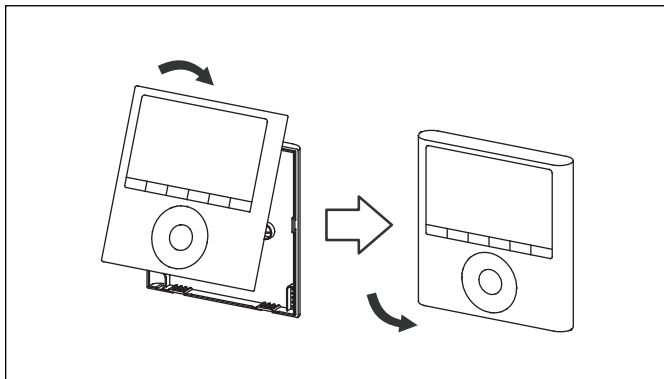

Figure 14

5.8 Installation Guide for Wall Mounted Indoor Unit Only

1. Open the front panel of the Wall Mounted Indoor Unit

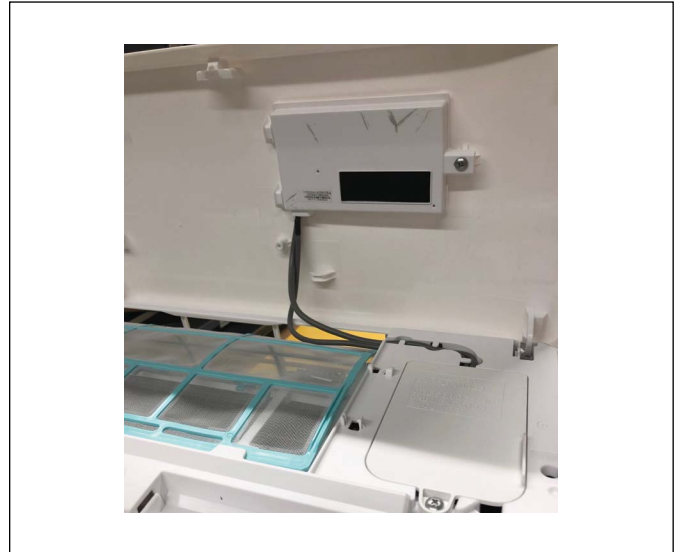

Figure 15

2. Disconnect the wire from the main control board.

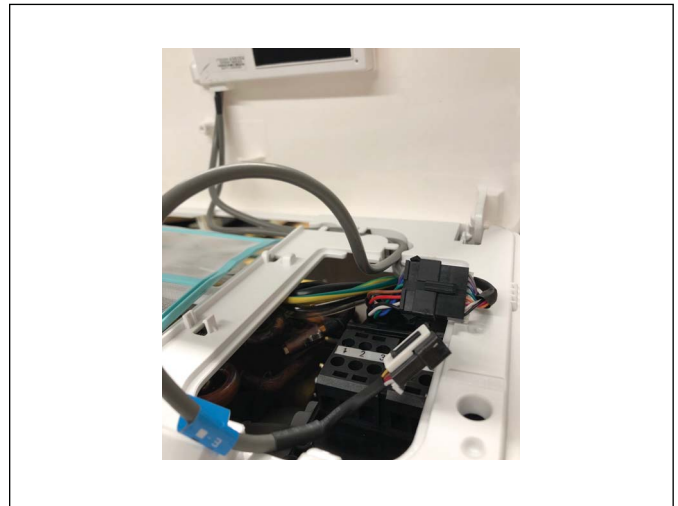

Figure 16

3. Identify the components. From left to right, display board and adapter board.

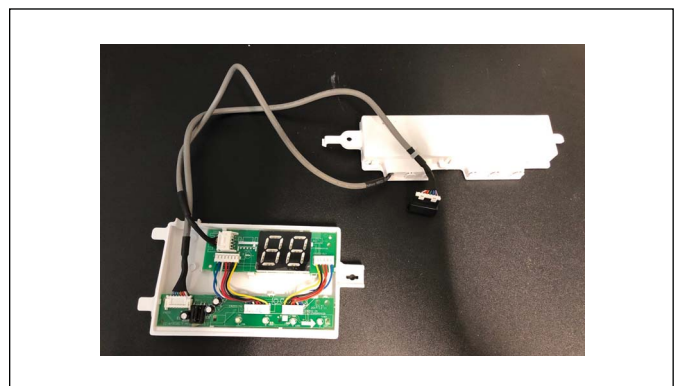

Figure 17

- Open adapter board's cover, connect 4 pin cable (red end) with CN403 from the board and close the cover.

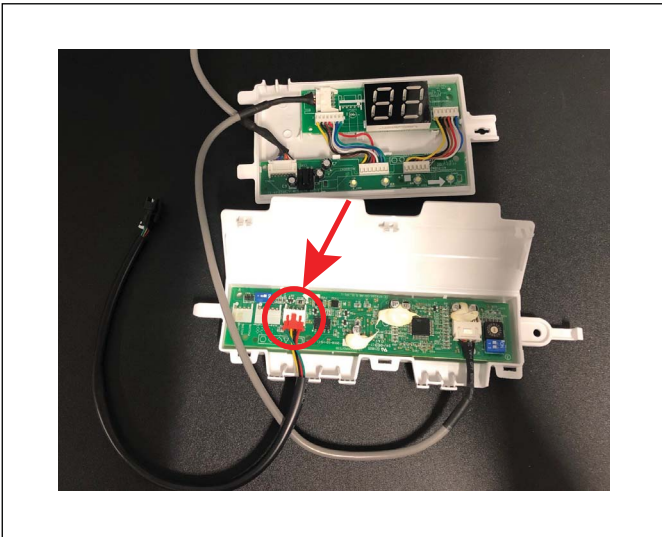

Figure 18

- Before mounting back on the front panel, remove the display board's screen cover.

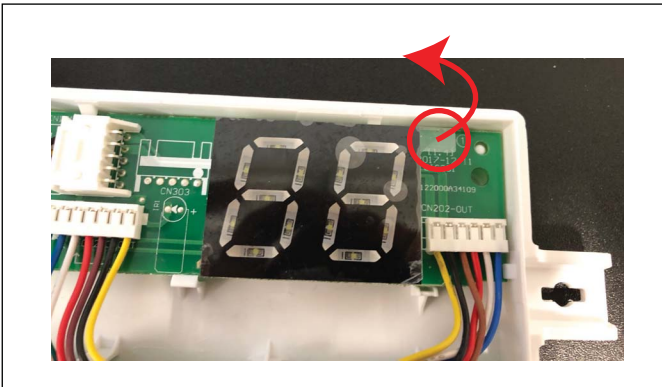

Figure 19

- Connect 4 pin (black) to Wired Wall Thermostat.

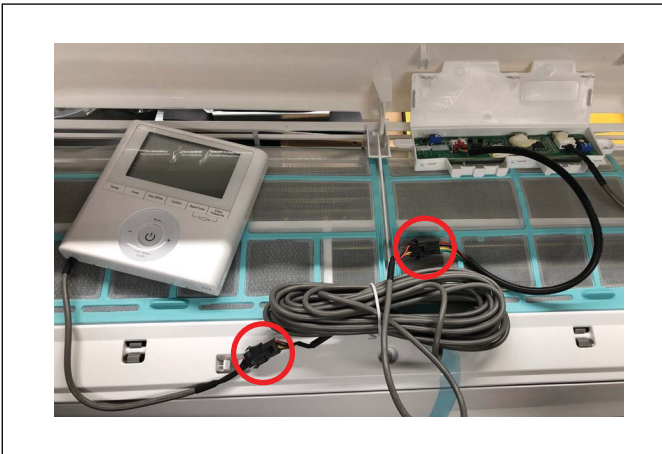

Figure 20

- Connect 8 pin connector from the display board to the IDU.

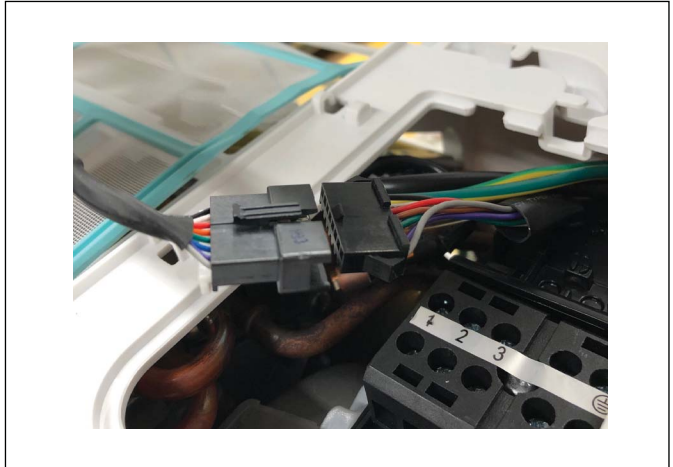

Figure 21

- Place display & adapter board on the back of the front panel and close the cover of IDU control box.



Figure 22

6 Operation Guideline

6.1 Set Date and Time

1. Press **TIMER** for 3s or more. The timer will flash.

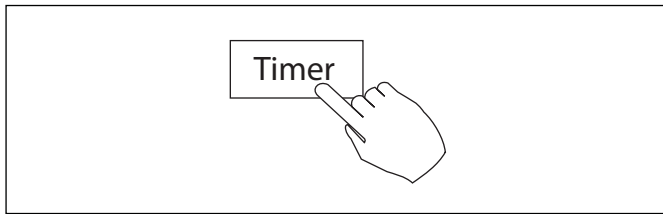

Figure 23

2. Press **+** or **-** to set the date. The selected date flashes.

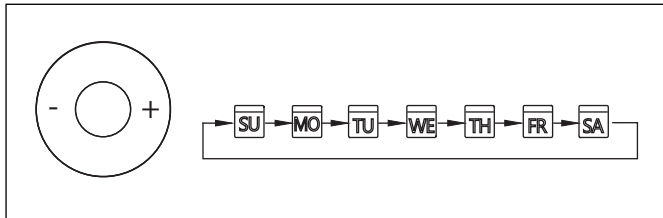

Figure 24

3. Date setting is complete and the time setting is ready after pressing **TIMER**.

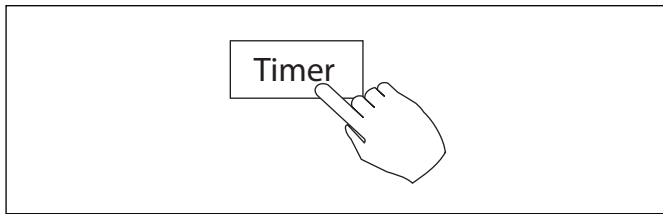

Figure 25

4. Press **+** or **-** to set the current time. Press repeatedly to adjust the current time in 1 minute increments.

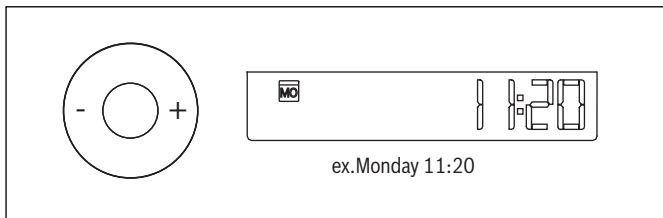

Figure 26

5. The setting is complete after pressing **TIMER**.

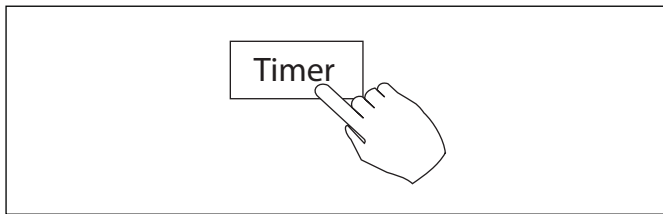

Figure 27

6.2 Cooling/Heating/Fan Operation

Ensure the unit is plugged in and power is available.

1. Press the power button.

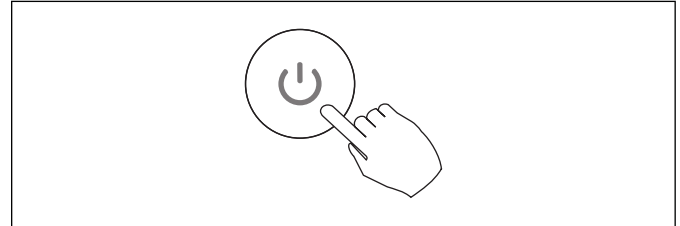

Figure 28

2. Press **Mode** to change / select desired operation mode.

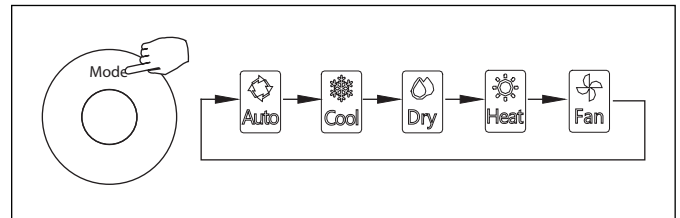

Figure 29

3. Press **+** or **-** to set desired temperature.

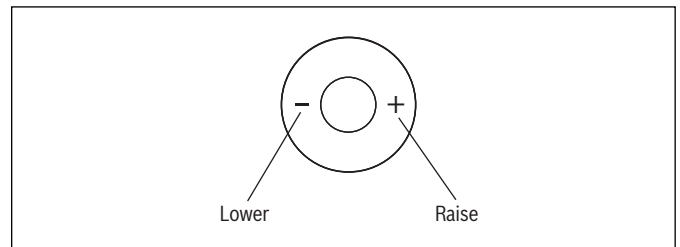

Figure 30

i In the **FAN** mode, the setting temperature is not displayed on the wired wall thermostat and you are not able to control the room temperature.

6.3 Change Fan Speed

1. Press **Fan Speed** to select desired fan speed or auto speed mode.

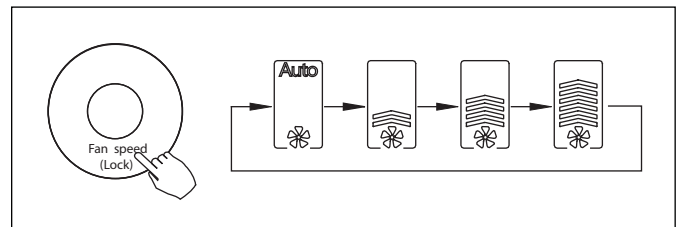

Figure 31

i Fan speed cannot be changed in **Dry** and **Auto** mode.

6.4 Follow Me Function (Wall Mounted Indoor Unit Only)

By default, room temperature will be measured from the sensor in indoor unit. Follow me function can be activated in order to detect room temperature from the wired wall thermostat rather than the indoor unit for better comfort.

1. Press Copy/Follow me to activate the function.

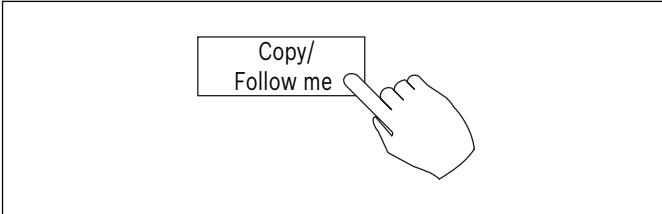

Figure 32

2. Follow me picture shows up on display.

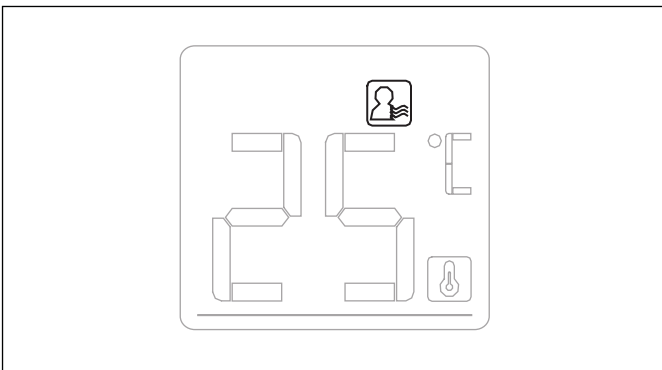

Figure 33



By default, Follow me function in the wired thermostat will be turned on with 4-Way Cassette and Ducted Indoor models.

6.5 Child Lock

1. Press LOCK for 3 seconds to activate the CHILD LOCK.

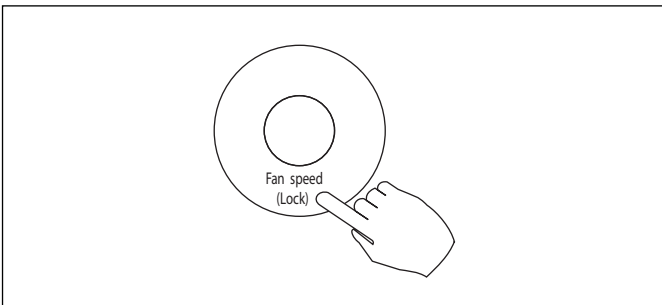

Figure 34

2. Press again for 3 seconds to deactivate.

6.6 Key Pad Tone Setting

1. Press Swing and Timer simultaneously for 3 seconds to disable the key pad tone.

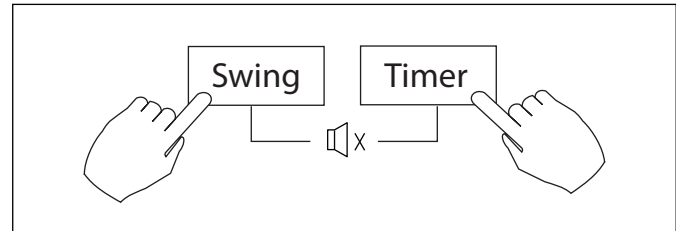

Figure 35

2. Press both buttons again for 3 seconds to enable the key pad tone.

6.7 °F/°C Selection

1. Press Back/Turbo and Timer simultaneously for 3 seconds to change between °F and °C.

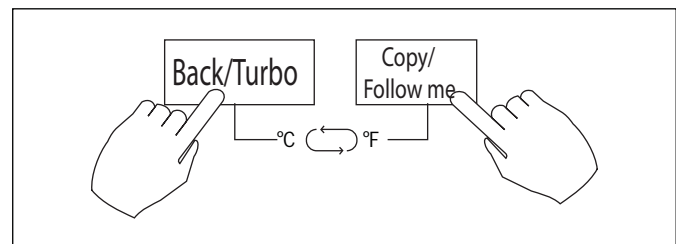

Figure 36

6.8 Turbo Mode

1. Press Back/Turbo to activate Turbo mode. Fan speed setting will be changed to the highest level to satisfy users' set temperature in the shortest time.

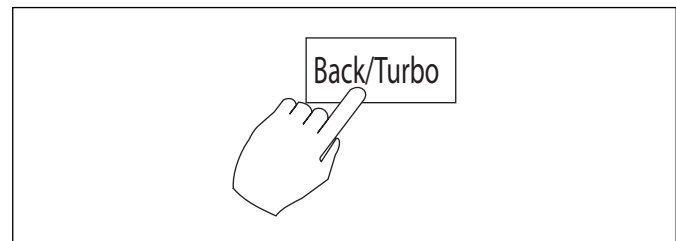

Figure 37

6.9 Decorative Grille Automatic Lift Up/Down (works with 4-Way Cassette Indoor only)

1. Turn off the system by pressing the Power button.

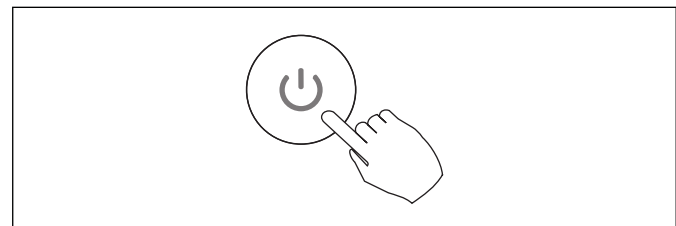

Figure 38

- Press and hold the Mode button to activate the automatic lift function. The faceplate icon will flash. F2 will be shown on the display when the grille can be adjusted.

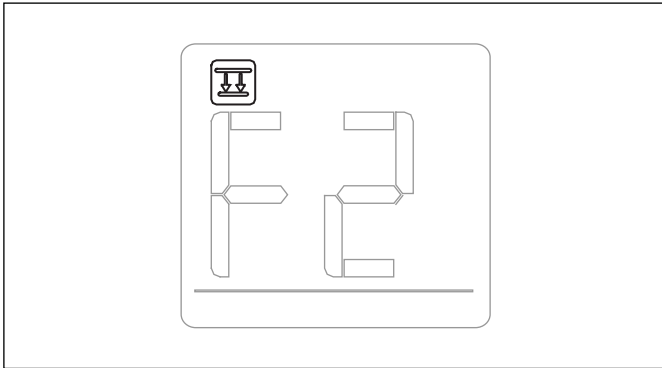

Figure 39

- Press + or - to control the lift up and down functions of the grille. While grille lifts down, press + to stop. While grille lifts up, press - to stop.

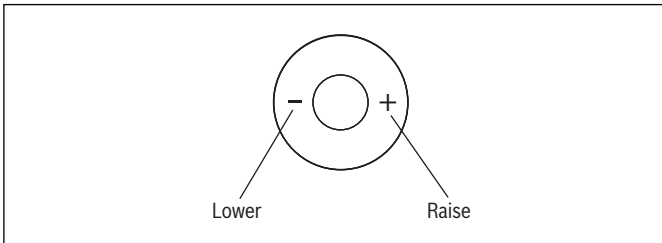

Figure 40

- When the auto swing mode is activated, the fan swing icon will appear on the display.

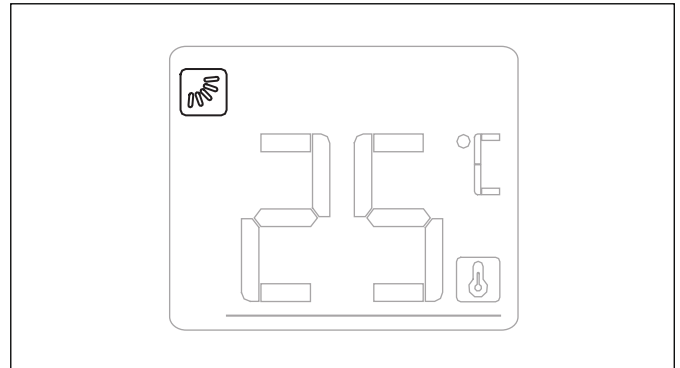
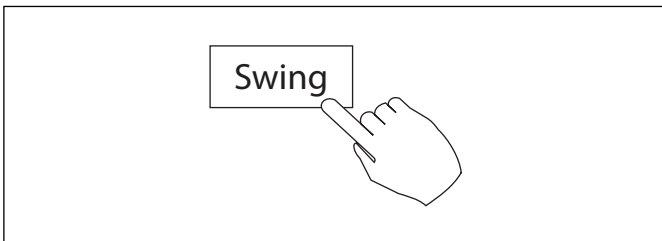

Figure 41

6.10 Swing Function

Louver Up-Down (applicable to Wall mounted and Cassette Indoor models only)

- The louver swings by six degrees every time when the Swing button is pressed.
- Press and hold Swing for 2 seconds to activate auto swing mode. Press Swing again to deactivate.



6.11 Scheduling

7-day schedule

Week — Daily schedule can be set

On timer

Day On — Operation starts after the set time

Off timer

Day Off — Operation stops after the set time

On and Off timer

Day On Off — Operation starts and stops after the set time

6.11.1 Programming 7-day Schedule

1. Press Timer to select the Week and press Confirm.

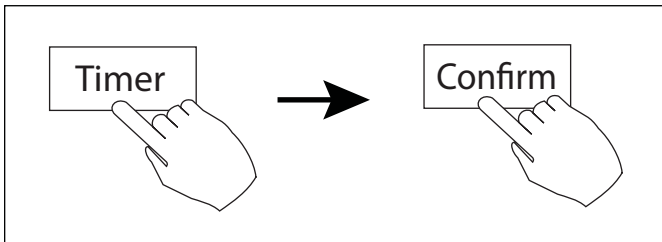

Figure 42

2. Press + or - to select the day of the week and then press CONFIRM.

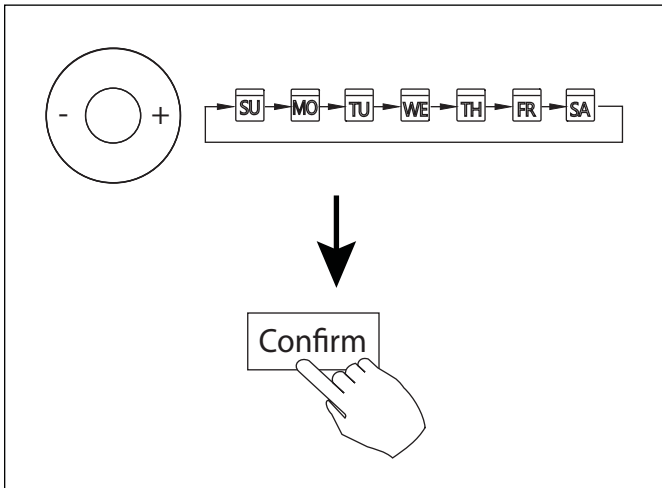

Figure 43

3. Press + and - to select the set time. The set time, mode, temperature and fan speed appear on the display. Press CONFIRM to enter the setting time process.

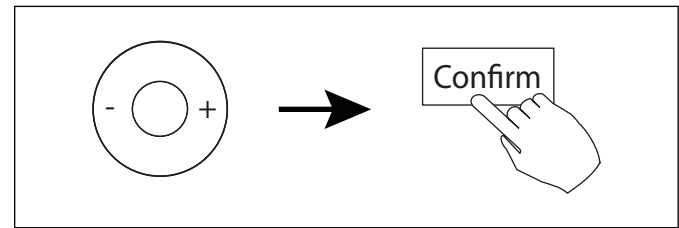

Figure 44



Up to 8 scheduled events can be set on one day.

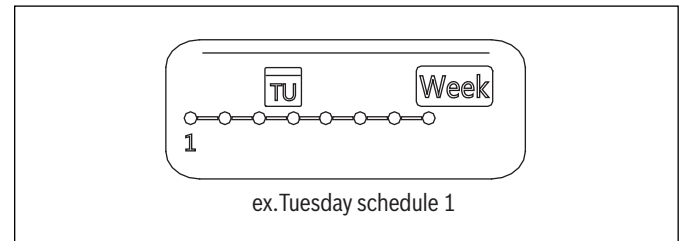

Figure 45

4. Press + and - to set the time then press CONFIRM.

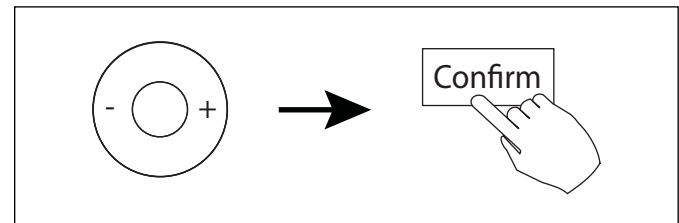

Figure 46

5. Press + and - to set the operation mode then press CONFIRM.

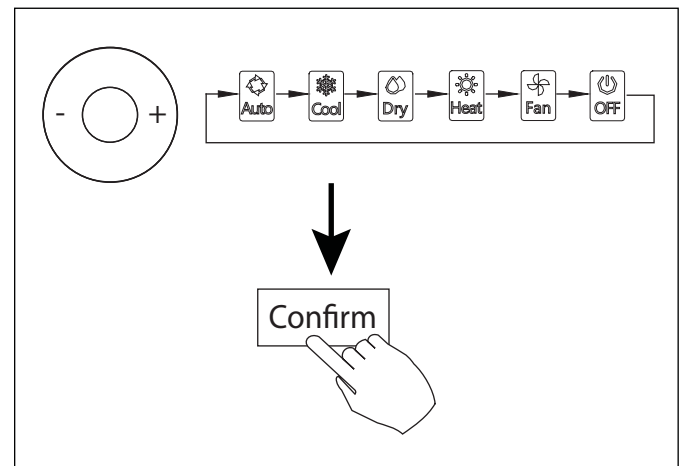

Figure 47

6. Press + and - to set the room temperature then press CONFIRM.

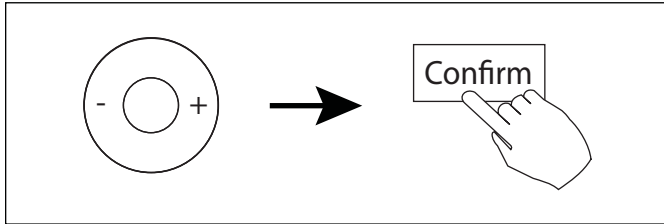

Figure 48

i This setting is unavailable in the FAN or OFF modes.

7. Press + and - to set the fan speed then press CONFIRM.

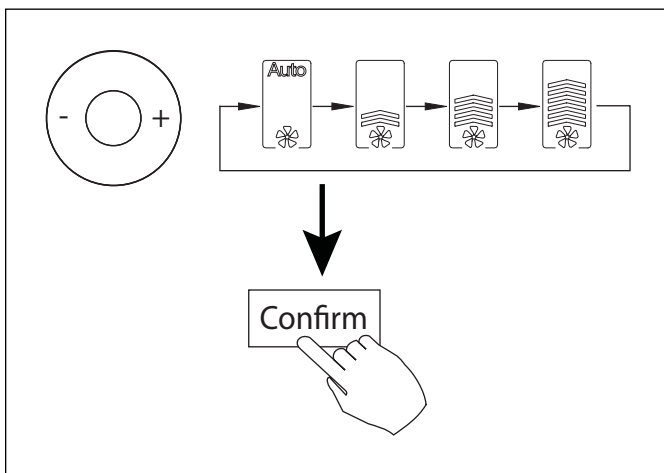

Figure 49

i This setting is unavailable in the AUTO, DRY or OFF modes.

8. Different schedules can be programmed by repeating steps 3 through 7.

6.11.2 Starting Saved 7-Day Schedule

To Start:

Press Timer to select the **Week**, and then the timer starts automatically.

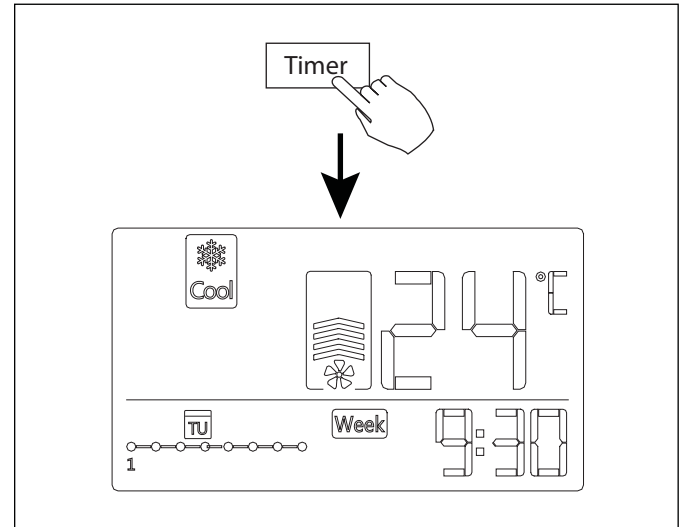

Figure 50

To Cancel:

Press Power to cancel the timer mode.

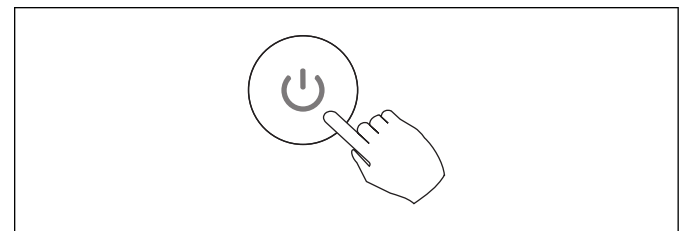

Figure 51

The timer mode can also be canceled by changing the timer mode using Timer.

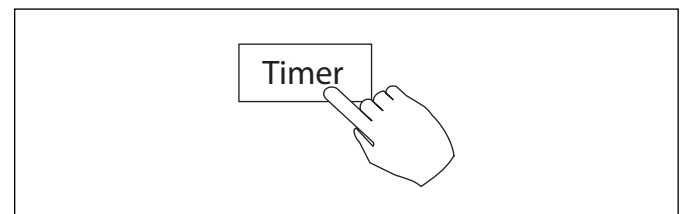

Figure 52

6.11.3 Set Day Off (Holiday)

1. After starting the 7-Day schedule, press CONFIRM.
2. Press + or - to select the day of the week.

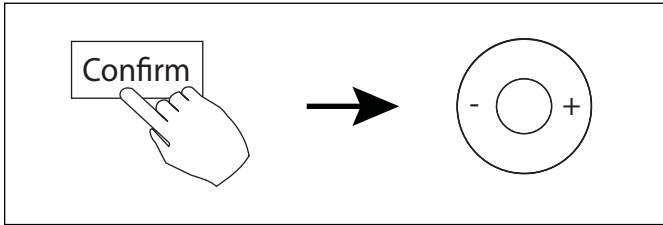

Figure 53

3. Press DAY OFF (holiday) to create an off day (holiday).

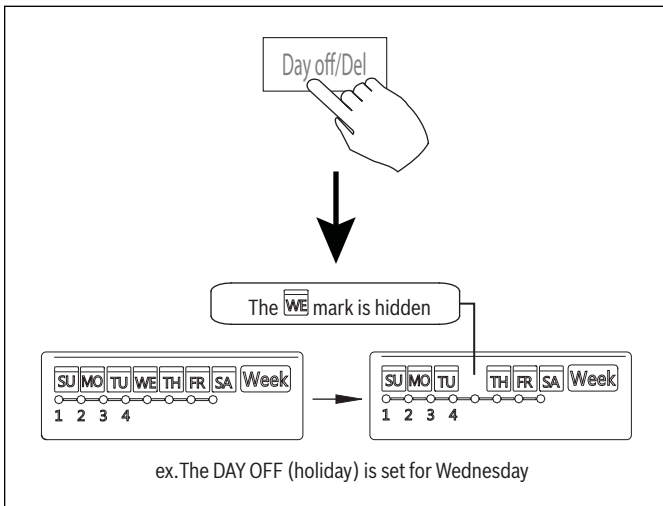

Figure 54

4. Set the DAY OFF (holiday) for other days by repeating the steps 2 and 3.
5. Press BACK to revert to the weekly timer.

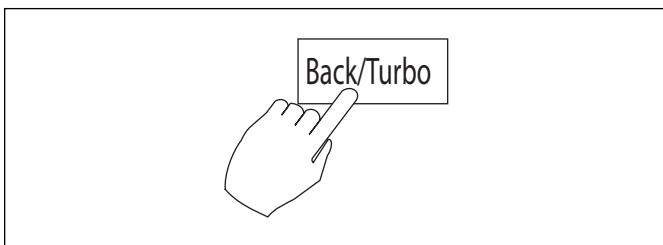

Figure 55

6. To cancel, follow the same procedures used for setup.



The DAY OFF (holiday) setting is cancelled automatically after the set day has passed.

6.12 Copy Existing Schedule

A saved schedule, can be copied to another day of the week.

1. After starting the 7-Day schedule, press CONFIRM.
2. Press + or - to select the day of the week.

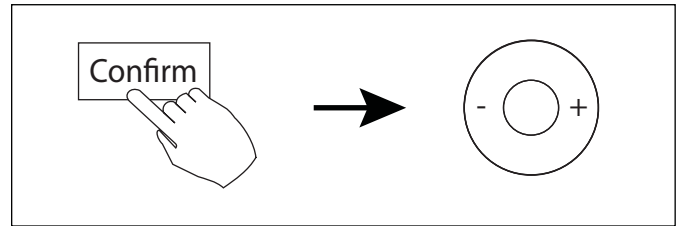

Figure 56

3. Press COPY, the letters CY appear on the display.

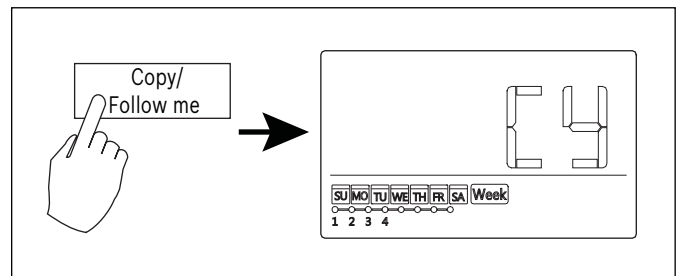

Figure 57

4. Press + or - to select the day to copy to.
5. Press COPY to confirm.

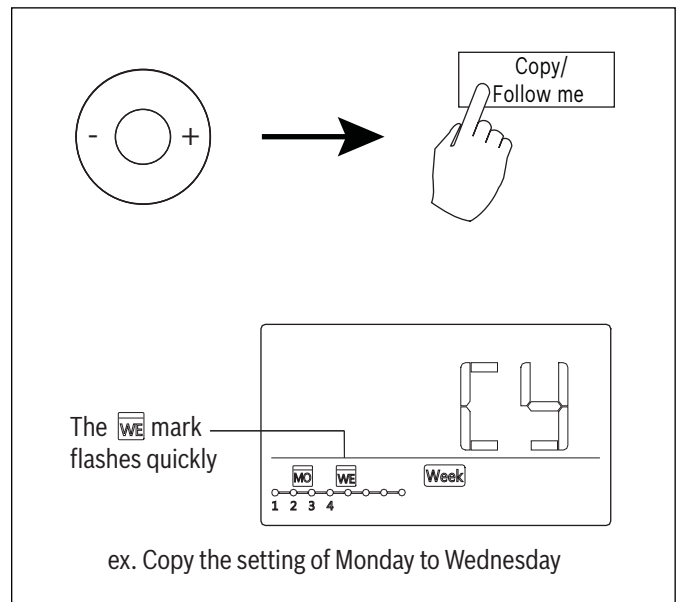

Figure 58

6. Other days can be copied by repeating steps 4 and 5.
7. Press CONFIRM to save the settings.

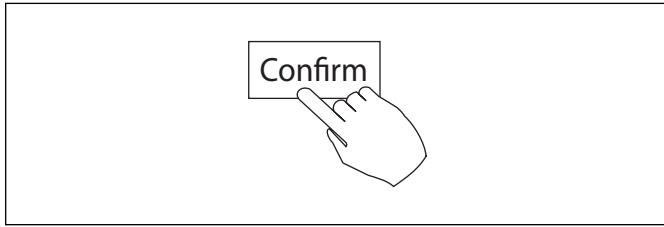

Figure 59

8. Press BACK to revert to the 7-Day schedule.

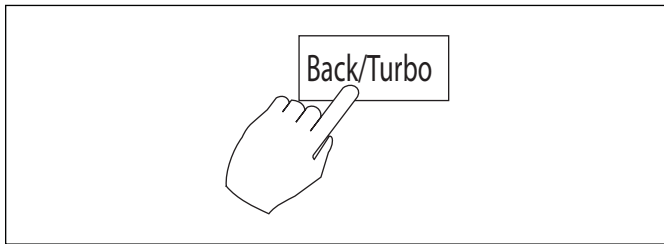

Figure 60

6.13 Delete Saved Schedule

1. Activate 7-day schedule and press CONFIRM.

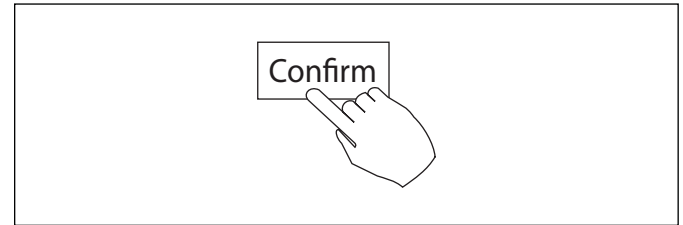

Figure 61

2. Press + and - to select the day to delete and then press CONFIRM.

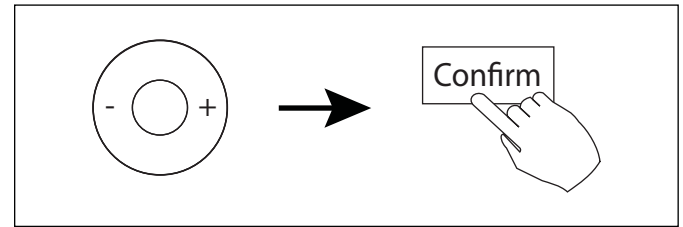

Figure 62

3. After selecting the day to be deleted, press Day off/Del to delete the saved setting.

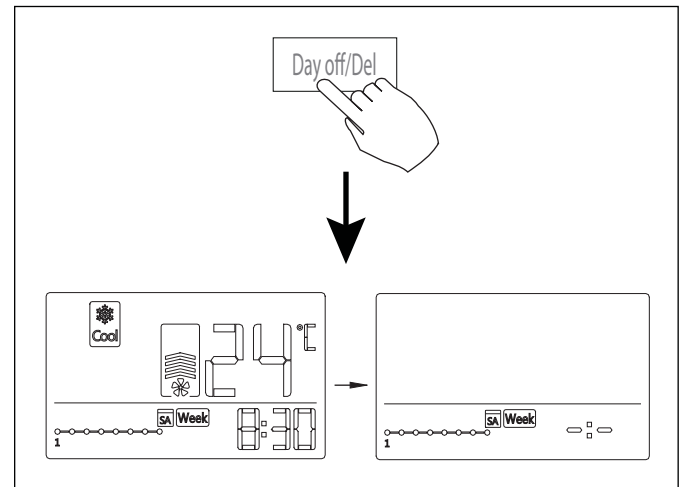

Figure 63

6.13 Set Timer On or Off Function

1. Press Timer to select the Day^{On} or Day^{Off}.

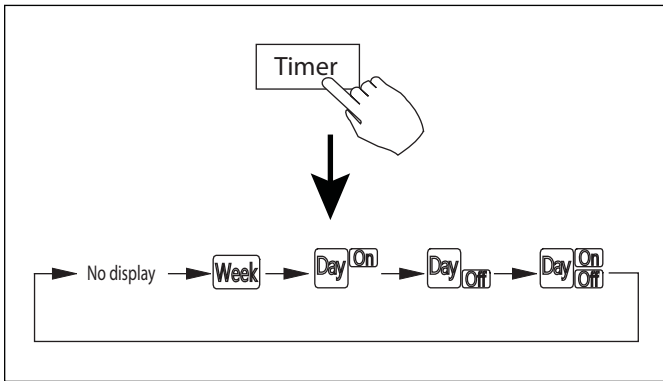

Figure 64

2. Press Confirm and the Clock display flashes.

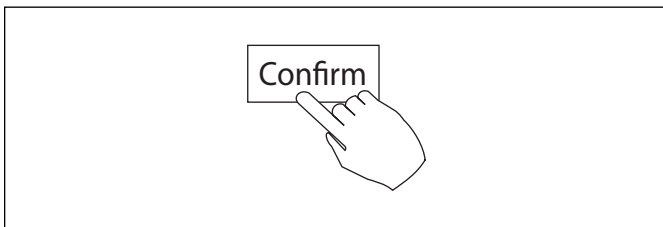

Figure 65

3. Press + or - to set the time. After the time is set, the timer starts or stops automatically.

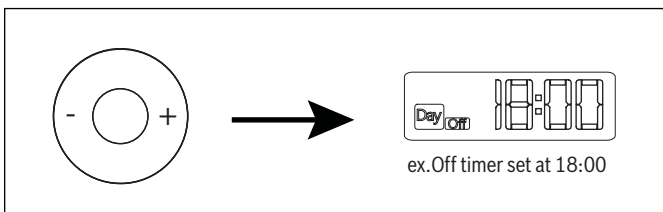

Figure 66

4. Press Confirm again to finish the settings.

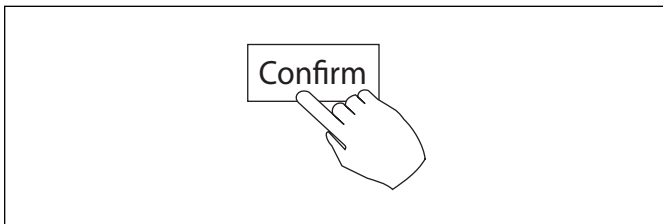

Figure 67

6.14 Set Timer On and Off Function

1. Press Timer to select the Day^{On} or Day^{Off}.

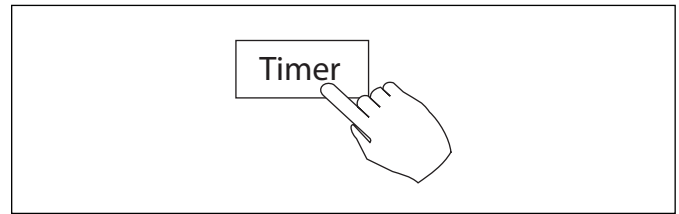

Figure 68

2. Press Confirm and the Clock display flashes.

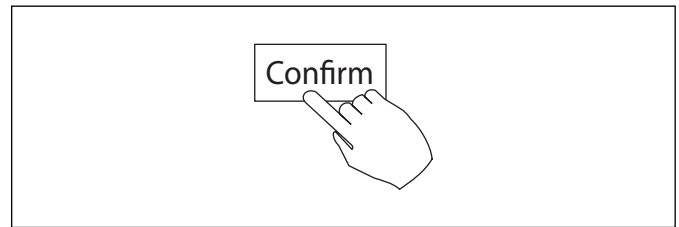

Figure 69

3. Press + and - to set the On timer and then press CONFIRM.

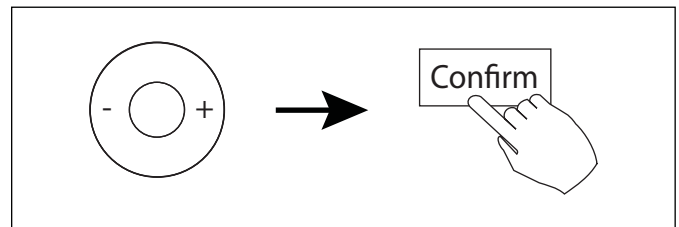

Figure 70

4. Press + or - to set the Off timer.

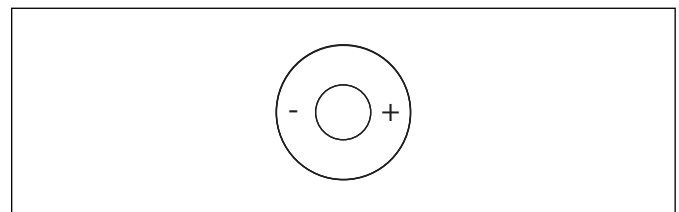

Figure 71

5. Press Confirm again to finish the setting.

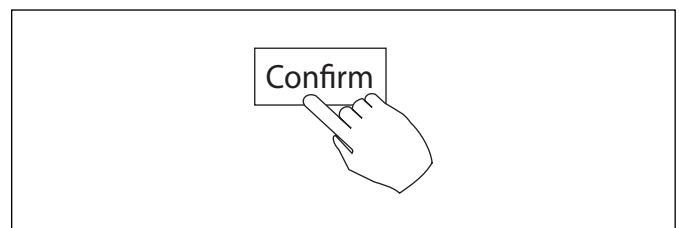

Figure 72

United States and Canada

**Bosch Thermotechnology Corp.
65 Grove Street
Watertown, MA 02472**

**Tel: 866-642-3198
Fax: 603-965-7581
www.boschheatingandcooling.com**